

National Aeronautics and Space Administration



REFERENCE GUIDE TO THE

INTERNATIONAL SPACE STATION

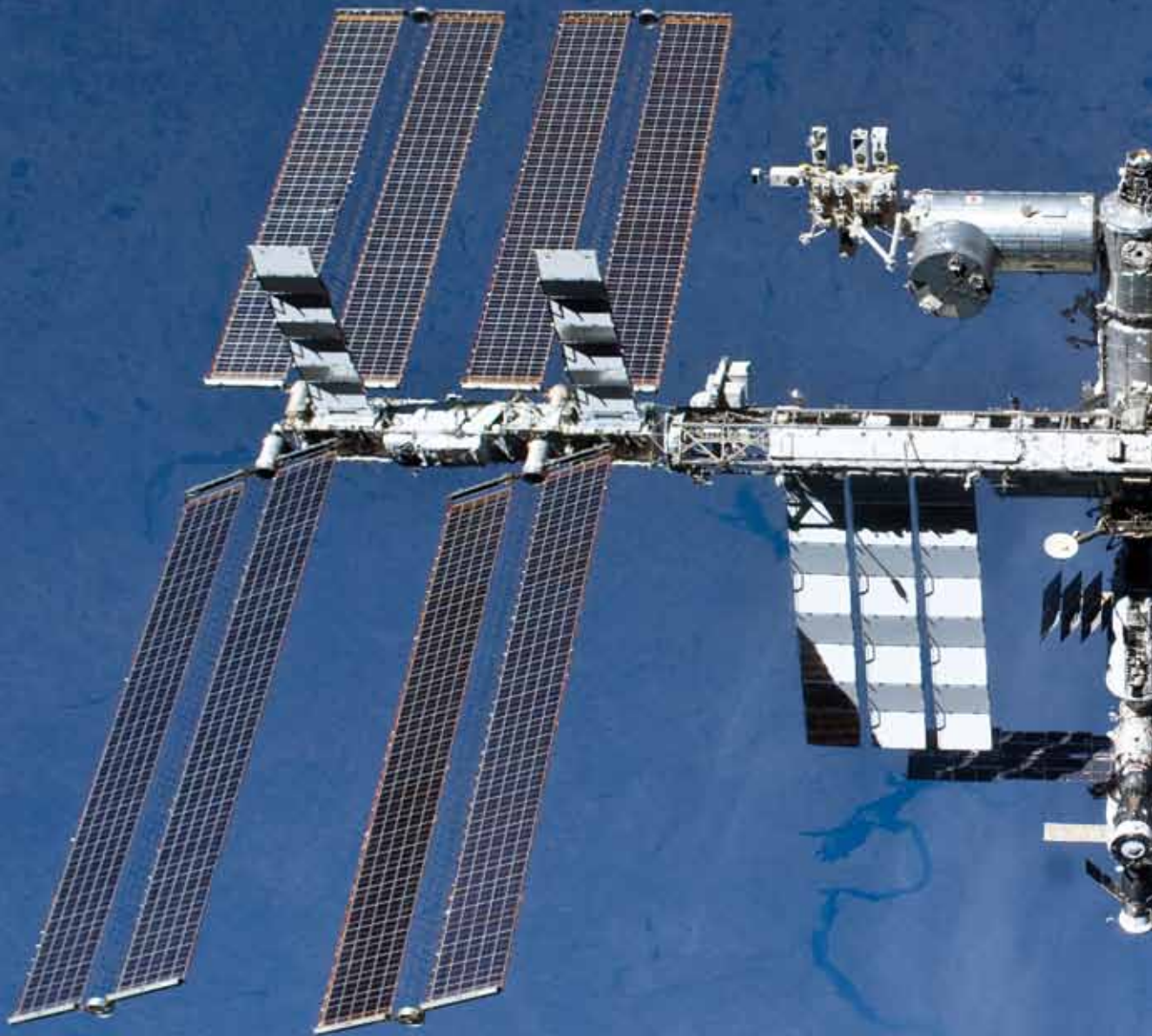


ASSEMBLY COMPLETE EDITION
NOVEMBER 2010



ISS
2009 Robert J. Collier Trophy winner

The Collier Trophy is awarded annually "for the greatest achievement in aeronautics or astronautics in America, with respect to improving the performance, efficiency, and safety of air or space vehicles, the value of which has been thoroughly demonstrated by actual use during the preceding year."



Library of Congress Cataloging-in-Publication Data

Reference guide to the International Space Station. -- Assembly complete ed.
p. cm.

Rev. ed. of the NASA document: Reference guide to the International Space Station.
August 2006.

"November 2010."

"NP-2010-09-682-HQ."

ISBN 0-16-086517-4

1. International Space Station. 2. Space stations--International cooperation. 3.
Manned space flight. I. United States. National Aeronautics and Space Administration.
TL797.R44 2010
629.44'2--dc22

2010040473

REFERENCE GUIDE TO THE

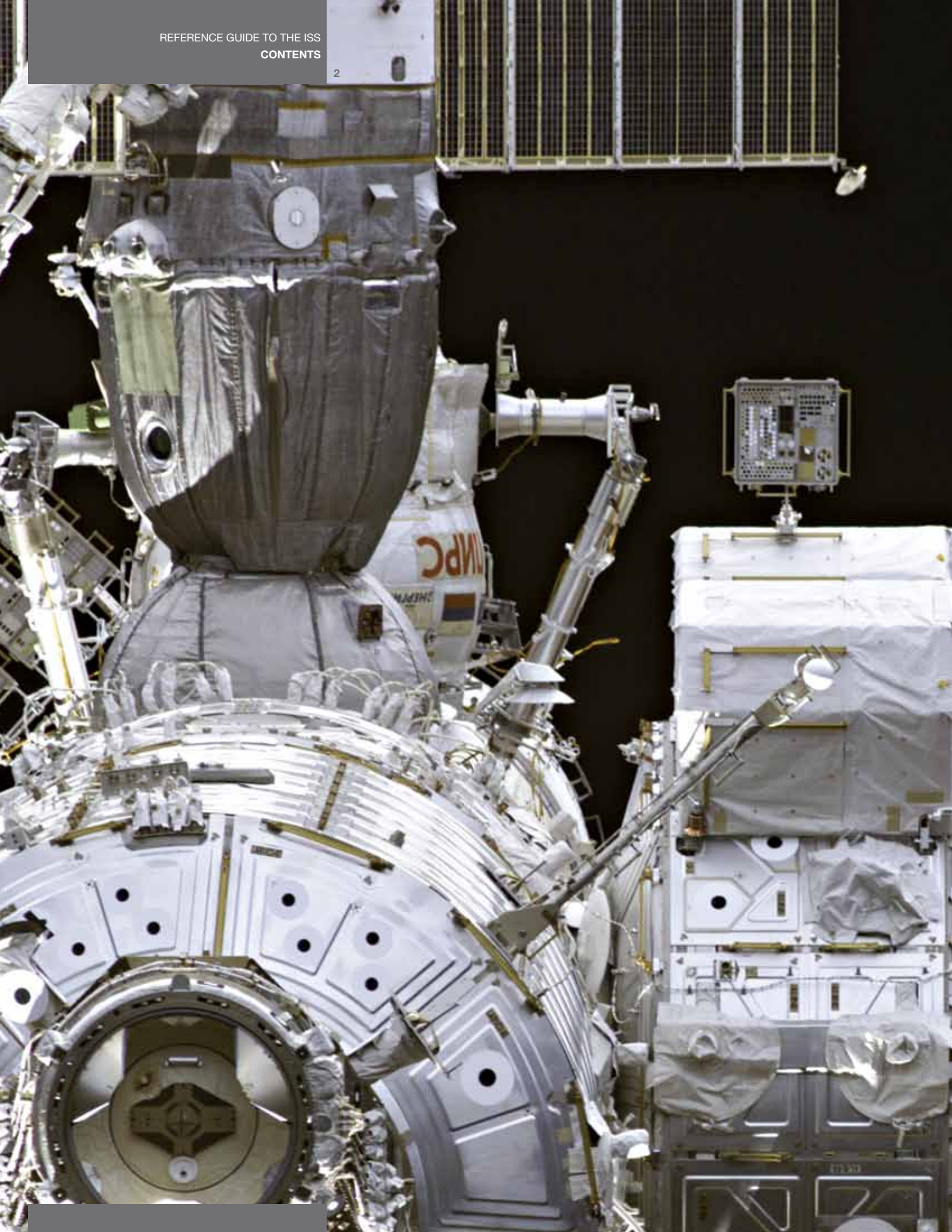
INTERNATIONAL SPACE STATION



ASSEMBLY COMPLETE EDITION
NOVEMBER 2010

National Aeronautics and Space Administration
Washington, DC

NP-2010-09-682-HQ

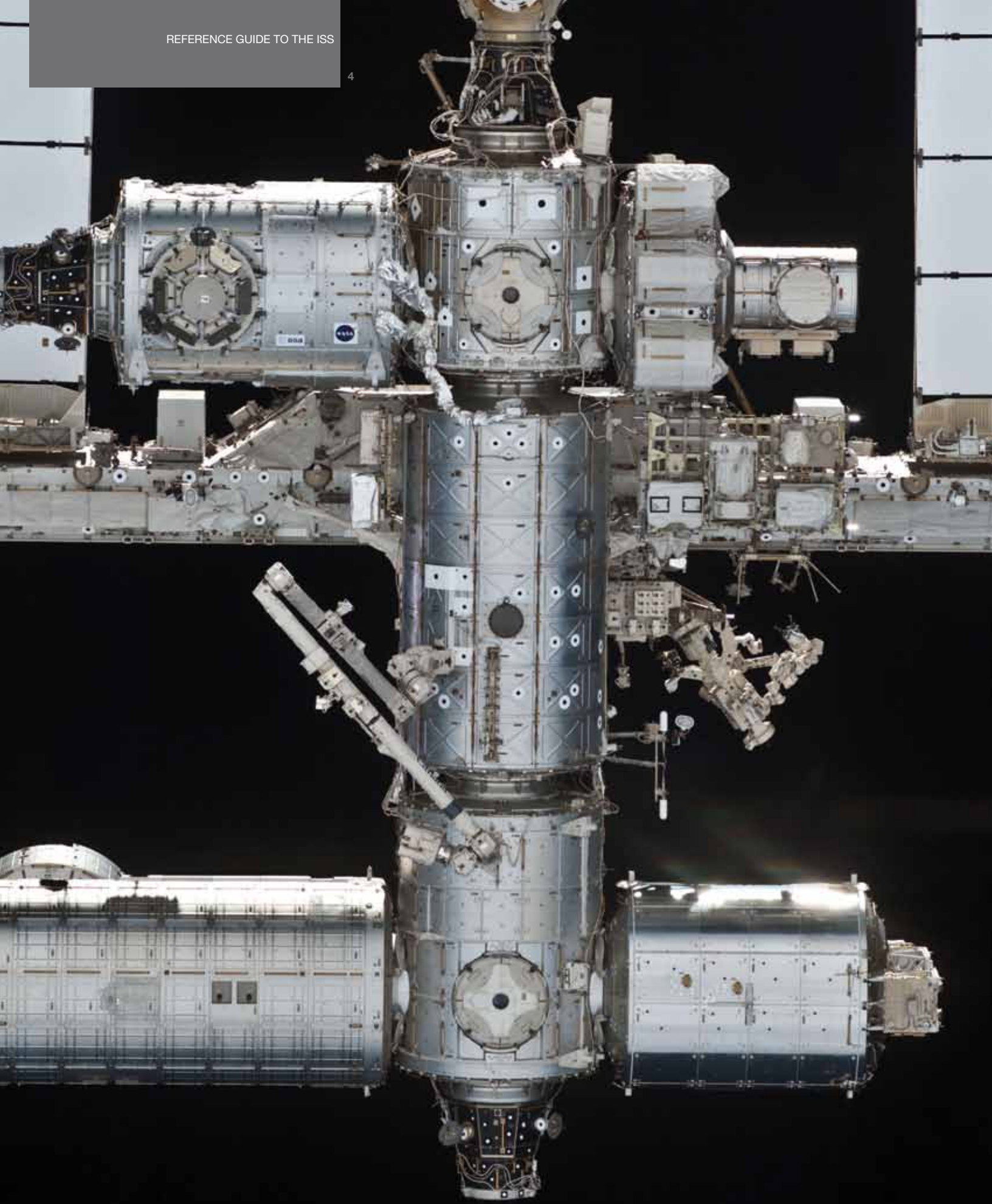


What It Does	7
Research Guide	21
How It's Put Together	45
How It's Supported	63
How the Crew Lives	79
How It Works	85
How It's Built	97
Missions	111
Appendix	129

contents



Shown in the foreground, a telephoto view of the U.S. Lab. Clockwise from the left, the Pressurized Mating Adapter, the Space Station Remote Manipulator System, Soyuz, and Pirs. In the background, the U.S. Airlock.





Assembly of the International Space Station (ISS) is a remarkable achievement. Since November 2, 2000, humankind has maintained a continuous presence in space. Over this timespan, the ISS International Partnership has flourished. We have learned much about construction and about how humans and spacecraft systems function on orbit. But there is much more to do and learn, and this voyage of research and discovery is just beginning. We now shift our focus from ISS assembly to full ISS utilization for scientific research, technology development, exploration, commerce, and education. We need to approach this next research phase with the same dedication, zeal, and innovation that we used to assemble the ISS. United States research concentrates on biology, human research, physical science and materials, Earth and space science, and technology for exploration beyond low-Earth orbit. As a national laboratory, the ISS is beginning to provide new opportunities for other agencies, academia, and commercial and other partners to pursue novel avenues of research and development, and to promote science, technology, engineering, and math education. We cannot now foresee all that may be uncovered on this voyage, but we look forward to the voyage and returning knowledge to extend the human presence beyond and improve life here on Earth.



—William H. Gerstenmaier
Associate Administrator
NASA Space Operations Mission Directorate



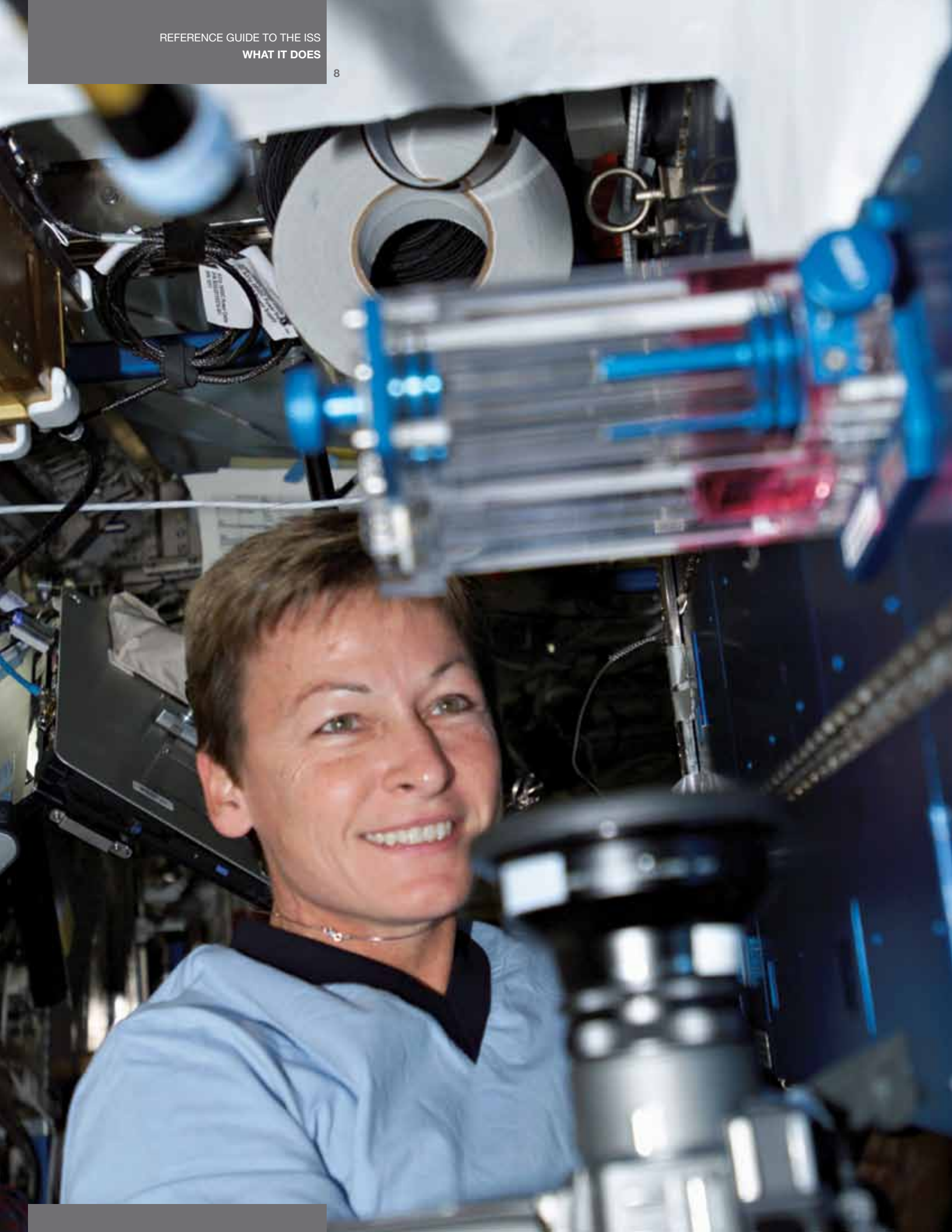
The International Space Station (ISS) is the unique blend of unified and diversified goals among the world's space agencies that will lead to improvements in life on Earth for all people of all nations. While the various space agency partners may emphasize different aspects of research to achieve their goals in the use of the ISS, they are unified in several important overarching goals.

All of the agencies recognize the importance of leveraging the ISS as an education platform to encourage and motivate today's youth to pursue careers in math, science, engineering, and technology (STEM): *educating the children of today to be the leaders and space explorers of tomorrow.*

Advancing our knowledge in the areas of human physiology, biology, and material and physical sciences and translating that knowledge to health, socioeconomic, and environmental benefits on Earth is another common goal of the agencies: *returning the knowledge gained in space research for the benefit of society.*

Finally, all the agencies are unified in their goals to apply knowledge gained through ISS research in human physiology, radiation, materials science, engineering, biology, fluid physics, and technology: *enabling future space exploration missions.*

what it does

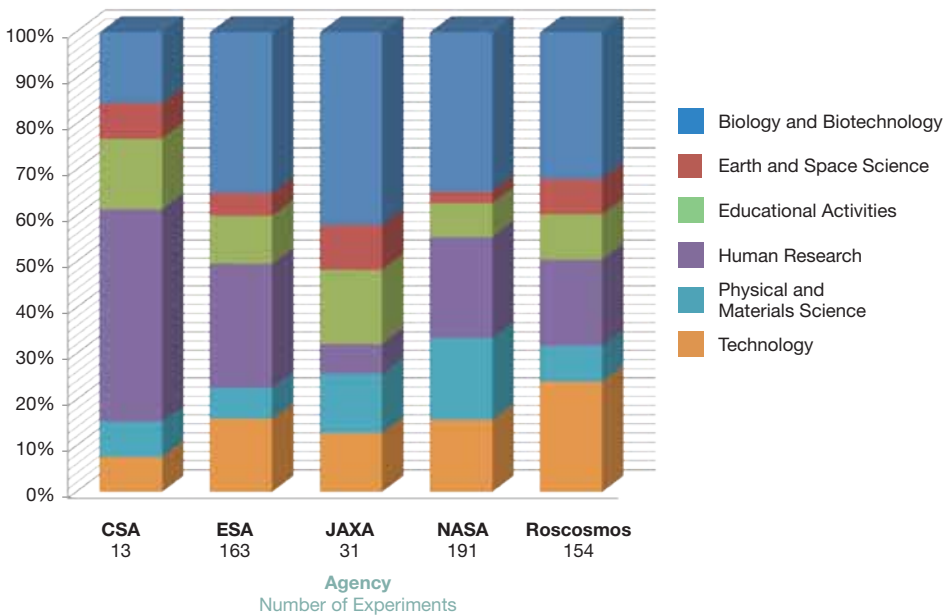


Plans Becoming a Reality

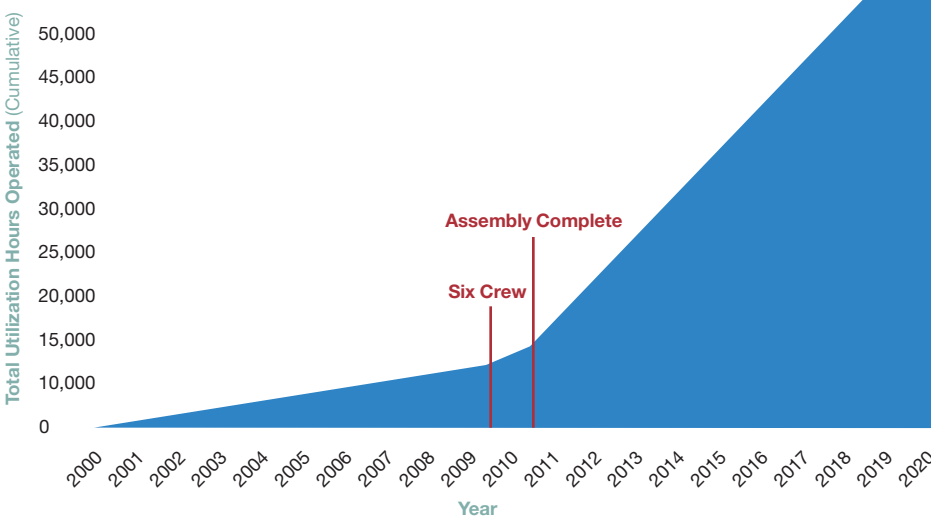
Almost as soon as the ISS was habitable, it was used to study the impact of microgravity and other space effects on several aspects of our daily lives. ISS astronauts conduct science daily across a wide variety of fields including human life sciences, biological science, human physiology, physical and materials science, and Earth and space science. Over 500 experiments have been conducted on the ISS as part of early utilization, over 10 years of continuous research.

In 2009, the number of astronauts living on board the ISS increased from three to six, and in 2010, the assembly of the ISS will be complete. As a result, more time will be spent on orbit performing ISS research. ISS laboratories are expected to accommodate an unprecedented amount of space-based research. Early utilization accomplishments give us hints about the value of a fully utilized ISS after assembly is complete.

Number of Experiments Performed Through Expeditions 21/22 (March 2010)



Cumulative ISS Utilization Crewtime by All Partners



Astronaut works with the Smoke Point In Co-flow Experiment in the Microgravity Sciences Glovebox (MSG) during Expedition 18.



Cosmonaut performs inspection of the BIO-5 Rasteniya-2 (Plants-2) experiment in the Russian Lada greenhouse.

Knowledge for All Humankind

Scientists from all over the world are already using ISS facilities, putting their talents to work in almost all areas of science and technology, and sharing their knowledge to make life on Earth better for people of all nations. We may not yet know what will be the most important knowledge gained from the ISS, but we do know that there are some amazing discoveries on the way! Several recent patents and partnerships have already demonstrated benefits of the public's investment in ISS research back on Earth.



Microbial Vaccine Development—Scientific findings from ISS research have shown increased virulence in *Salmonella* bacteria flown in space and identified the controlling gene responsible. AstroGenetix, Inc., has funded their own follow-on studies on the ISS and are now pursuing approval of a vaccine of an Investigational New Drug (IND) with the Food and Drug Administration (FDA). The company is now applying a similar development approach to methicillin-resistant *Staphylococcus aureus* (MRSA).

Crew Earth Observations—International Polar Year (CEO-IPY) supported an international collaboration of scientists studying Earth's polar regions from 2007 to 2009. ISS crewmembers photographed polar phenomena including icebergs, auroras, and mesospheric clouds. Observations, through digital still photography and video, from the ISS are used in conjunction with data gathered from satellites and ground observations to understand the current status of the polar regions. The ISS, as a platform for these observations, will contribute data that have not been available in the past and will set the precedent for future international scientific collaborations for Earth observations. The International Polar Year, which started in 2007 and extended through February 2009, is a global campaign to study Earth's polar regions and their role in global climate change.

Lab-on-a-Chip Application Development—Portable Test System (LOCAD-PTS) is a handheld device for rapid detection of biological and chemical substances on surfaces aboard the ISS. Astronauts swab surfaces within the cabin, mix swabbed material in liquid form to the LOCAD-PTS, and obtain results within 15 minutes on a display screen, effectively providing an early warning system to enable the crew to take remedial measures if necessary to protect themselves on board the ISS. The handheld device is used with three different types of cartridges for the detection of endotoxin (a marker of gram-negative bacteria), glucan (fungi), and lipoteichoic acid (gram-positive bacteria). Lab-on-a-Chip technology has an ever-expanding range of applications in the biotech industry. Chips are available (or in development) that can also detect yeast, mold, and gram-positive bacteria; identify environmental contaminants; and perform quick health diagnostics in medical clinics.

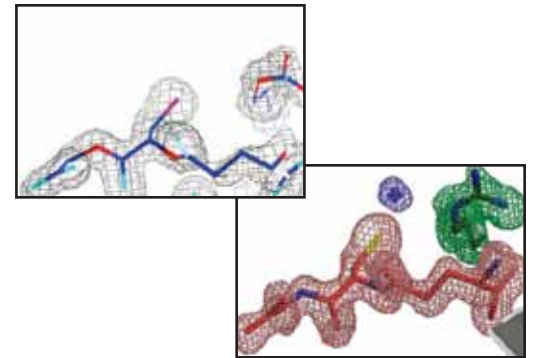


The **Plasma Crystal** experiment was one of the first scientific experiments performed on the ISS in 2001. Complex plasma is a low-temperature gaseous mixture composed of ionized gas, neutral gas, and micron-sized particles. Under specific conditions, the interactions of these microparticles lead to a self-organized structure of a “plasma crystal” state of matter. Gravity causes the microparticles to sediment due to their relatively high mass compared to that of the ions, and so they have to be electrostatically levitated for proper development. The microgravity environment of the ISS allowed the development of larger three-dimensional plasma crystal systems in much weaker electric fields than those necessary for the levitation on the ground, revealing unique structural details of the crystals. The European Space Agency (ESA) is now building the next generation of complex plasma experiments for the ISS in collaboration with a large international science team. Understanding the formation and structure of these plasma crystal systems can also lead to improvements in industrial process development on Earth.



Dusty plasma in microgravity.

Plasma Crystal 3 Plus [Roscosmos, DLR (German Aerospace Center), ESA], as well as previous experiments of this series, is one example of a complex set of plasma crystal experiments that allow scientists to study crystallization and melting of dusty plasma in microgravity by direct viewing of those phenomenon. The equipment includes a tensor unit, turbo pump, and two TEAC Aerospace Technologies video tape recorders are part of the telescience equipment. Video recordings of the plasma crystal formation process, along with parameters such as gas pressure, high-frequency radiated power and the size of dust particles are downlinked to Earth for analysis.



Electron density maps of HQL-79 crystals grown on Earth show a smaller three-dimensional structure (resolution of 1.7 Angströms, top left) as compared to the HQL-79 crystals grown in space (resolution of 1.28 Angströms, lower right).

New Treatment Options for Duchenne Muscular Dystrophy: Collaborative High Quality Protein Crystal Growth

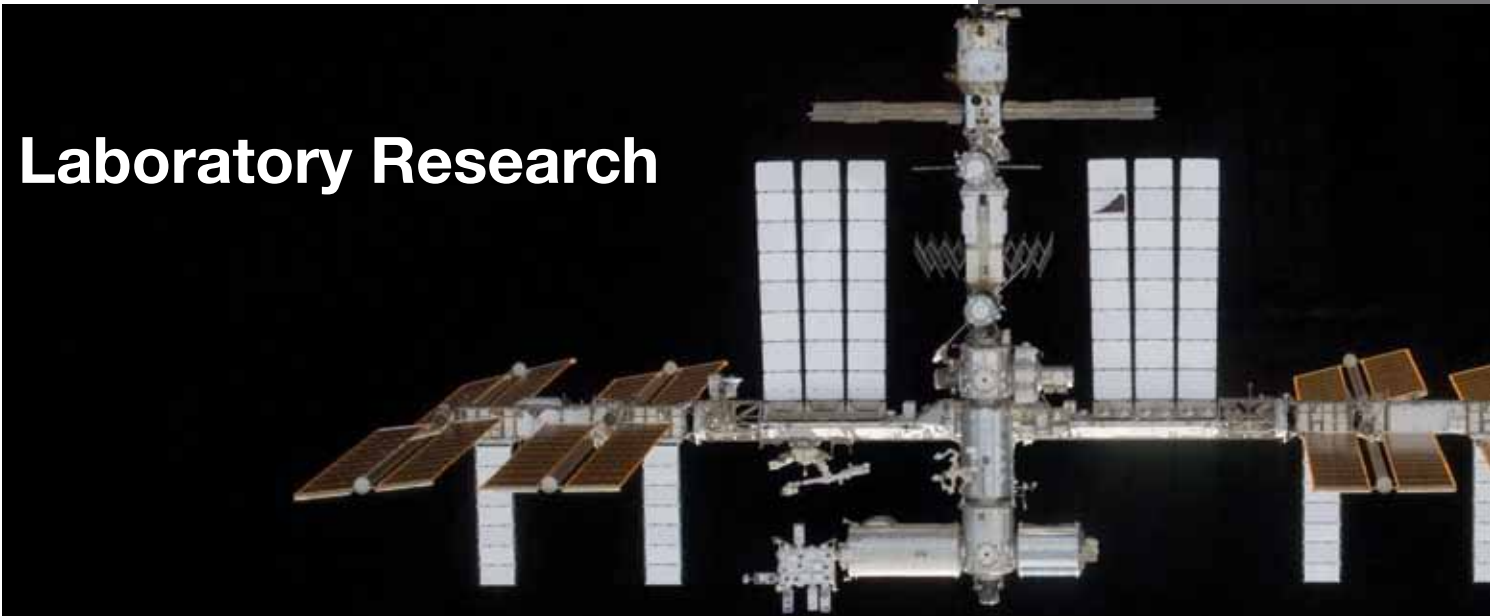
This JAXA- and Roscosmos-sponsored investigation was a unique collaboration between several ISS International Partners. The HQL-79 (human hematopoietic prostaglandin D2 synthase inhibitor) protein is a candidate treatment in inhibiting the effects of Duchenne muscular dystrophy. Investigators used the microgravity environment of the ISS to grow larger crystals and more accurately determine the three-dimensional structures of HQL-79 protein crystals. The findings led to the development of a more potent form of the protein, which is important for the development of a novel treatment for Duchenne muscular dystrophy. Russian investigators have collaborated internationally to grow macromolecular crystals on ISS since 2001, including genetically engineered human insulin (deposited into protein data bank in 2008), tuberculosis, and cholera-derived pyrophosphatase. The next generation of Russian-Japanese collaboration is the JAXA-High Quality Protein Crystal Growth experiment installed in Kibo in August 2009.



Advanced Diagnostic Ultrasound in Microgravity (ADUM)— The ultrasound is the only medical imaging device currently available on the ISS. This experiment demonstrated the diagnostic accuracy of ultrasound in medical contingencies in space and determined the ability of minimally trained crewmembers to perform ultrasound examinations with remote guidance from the ground. The telemedicine strategies investigated by this experiment could have widespread application and have been applied on Earth in emergency and rural care situations. In fact, the benefits of this research are being used in professional and amateur sports from hockey, baseball, and football teams to the U.S. Olympic Committee. Sport physicians and trainers can now perform similar scans on injured players at each of their respective sport complexes by taking advantage of ultrasound experts available remotely at the Henry Ford Medical System in Detroit. This is an excellent example of how research aboard the ISS continues to be put to good use here on Earth while, at the same time, paving the way for our future explorers.

An ISS investigator recently patented the **Microparticle Analysis System and Method**, an invention for a device that detects and analyzes microparticles. This technology supports the chemical and pharmaceutical industries and is one of a sequence of inventions related to technology development for experiments on the ISS and Shuttle, including the Microencapsulation Electrostatic Processing System (MEPS) experiment that demonstrated microencapsulation processing of drugs, a new and powerful method for delivering drugs to targeted locations. MEPS technologies and methods have since been developed that will be used to deliver microcapsules of anti-tumor drugs directly to tumor sites as a form of cancer therapy.

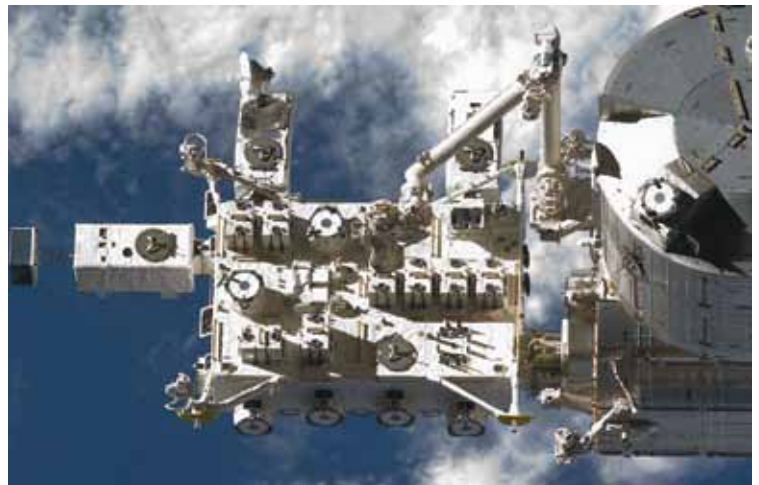
Laboratory Research



NASA astronaut Nicole Stott, Expedition 21 flight engineer, installs hardware in the Fluids Integrated Rack (FIR) in the Destiny laboratory of the ISS.

The laboratories of the ISS are virtually complete; key research facilities—science laboratories in space—are up and running. In 2008, the ESA Columbus and JAXA Kibo laboratories joined the U.S. Destiny Laboratory and the Russian Zvezda Service Module. Zvezda was intended primarily to support crew habitation but became the first multipurpose research laboratory of the ISS. In addition, the U.S. has expanded its user base beyond NASA to other government agencies and the private sectors to make the ISS a U.S. National Laboratory.

As all ISS partner nations begin their research programs, international collaboration and interchange among scientists worldwide is growing rapidly. Over the final years of assembly in 2009–2010, the initial experiments have been completed in the newest racks, the crew size on board ISS has doubled to six astronauts/cosmonauts, and in 2010 we will transition from “early utilization” to “full utilization” of ISS. The ISS labs are GO!



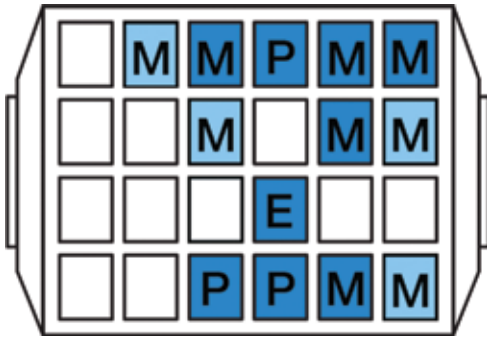
Japanese Experiment Module External Facility (JEM EF) with the Remote Manipulator System arm and three payloads installed.

This high-flying international laboratory is packed with some of the most technologically sophisticated facilities that can support a wide range of scientific inquiry in biology, human physiology, physical and materials sciences, and Earth and space science. There is probably no single place on Earth where you can find such a laboratory—approximately the size of an American football field (including the end zones) and having the interior volume of 1.5 Boeing 747 jetliners—with facilities to conduct the breadth of research that can be done aboard the ISS. Keep turning the pages to learn more about this amazing laboratory orbiting approximately 350 km (220 mi) above us.

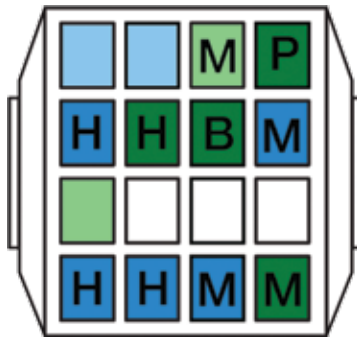
Laboratory Facilities



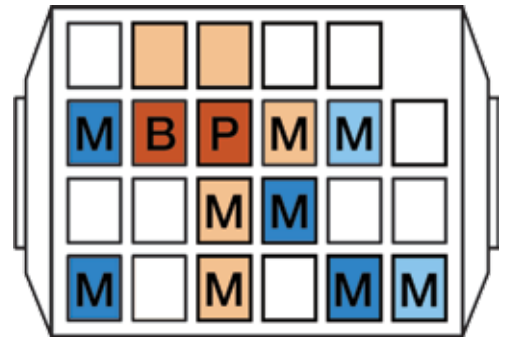
ISS Laboratory Research Rack Locations at Assembly Complete



U.S. Laboratory
Destiny



European Laboratory
Columbus



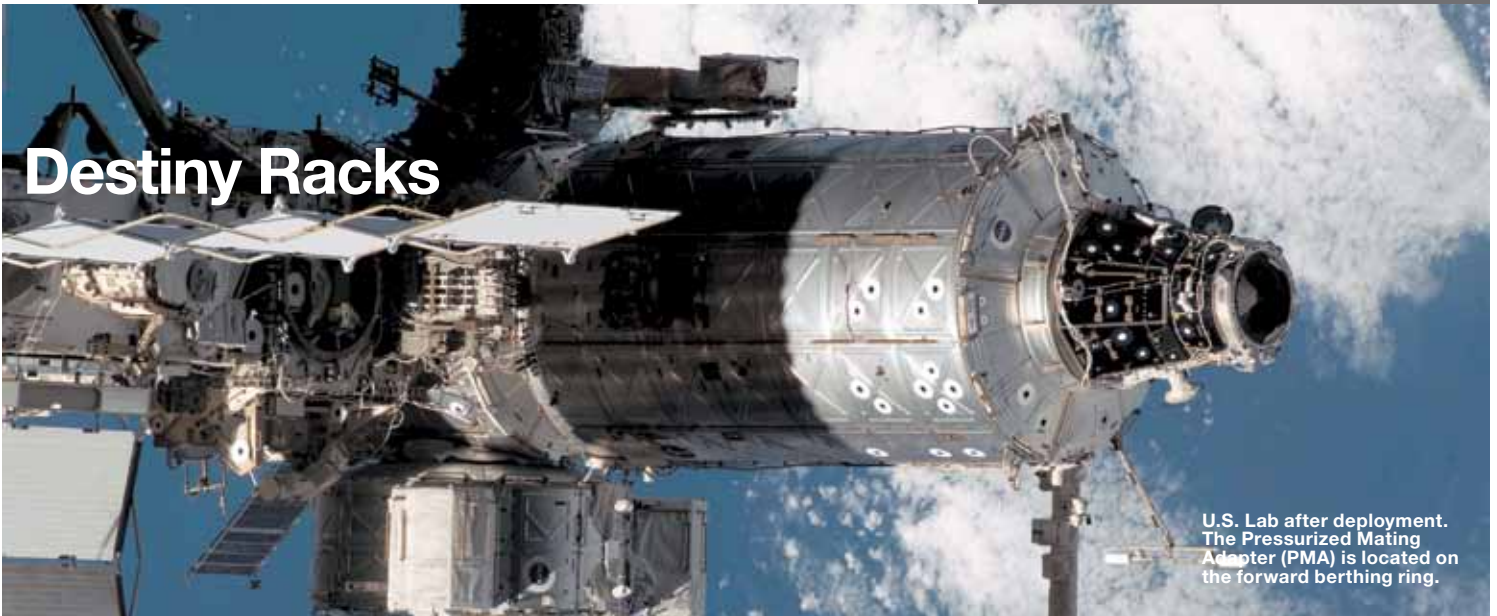
Japanese Laboratory
Kibo

- B Biological Sciences
- H Human Research
- P Physical Sciences and Materials Research
- M Multipurpose
- Systems and Stowage
- E Earth Science

	ULF-4	Utilization/ Stowage/Future
NASA		
JAXA		
ESA		



Astronaut Karen Nyberg works in the newly installed Kibo Japanese Pressurized Module.



Destiny Racks

U.S. Lab after deployment. The Pressurized Mating Adapter (PMA) is located on the forward berthing ring.

EXPRESS Rack 1



Sub-rack-sized experiments with standard utilities such as power, data, cooling, and gases.

EXPRESS Rack 2



Sub-rack-sized experiments with standard utilities such as power, data, cooling, and gases.

EXPRESS Rack 6



Sub-rack-sized experiments with standard utilities such as power, data, cooling, and gases.

EXPRESS Rack 7



Sub-rack-sized experiments with standard utilities such as power, data, cooling, and gases.

Combustion Integrated Rack (CIR)



Used to perform sustained, systematic combustion experiments in microgravity.

Fluids Integrated Rack (FIR)



A complementary fluid physics research facility designed to accommodate a wide variety of microgravity experiments.

Materials Science Research Rack-1 (MSRR-1)



Accommodates studies of many different types of materials.

Window Observational Research Facility (WORF)



Provides a facility for Earth science research using the Destiny science window on the ISS.

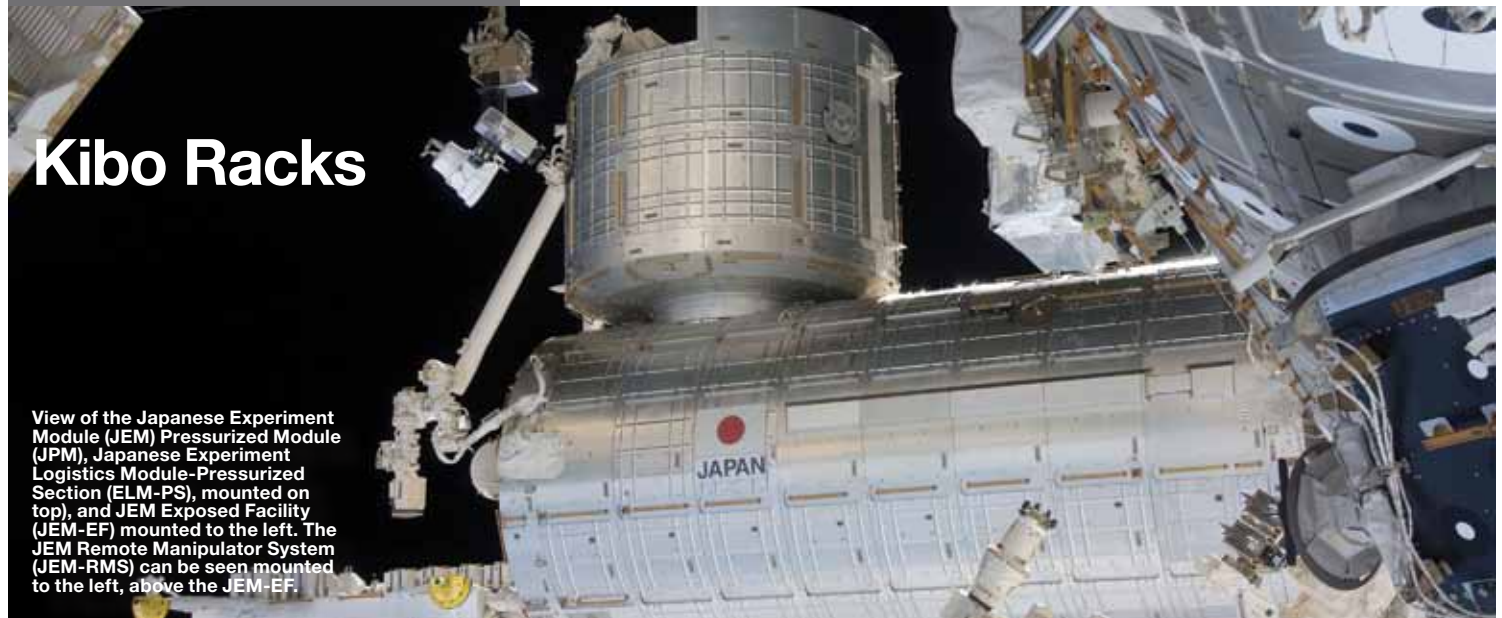
Minus Eighty-Degree Laboratory Freezer for ISS (MELFI-2)



A refrigerator/freezer for biological and life science samples.

Kibo Racks

View of the Japanese Experiment Module (JEM) Pressurized Module (JPM), Japanese Experiment Logistics Module-Pressurized Section (ELM-PS), mounted on top, and JEM Exposed Facility (JEM-EF) mounted to the left. The JEM Remote Manipulator System (JEM-RMS) can be seen mounted to the left, above the JEM-EF.



Minus Eighty-Degree Laboratory Freezer for ISS (MELFI-1)



A refrigerator/freezer for biological and life science samples.

Minus Eighty-Degree Laboratory Freezer for ISS (MELFI-3)



A refrigerator/freezer for biological and life science samples.

EXPRESS Rack 4



Sub-rack-sized experiments with standard utilities such as power, data, cooling, and gases.

EXPRESS Rack 5



Sub-rack-sized experiments with standard utilities such as power, data, cooling, and gases.

Ryutai Experiment Rack



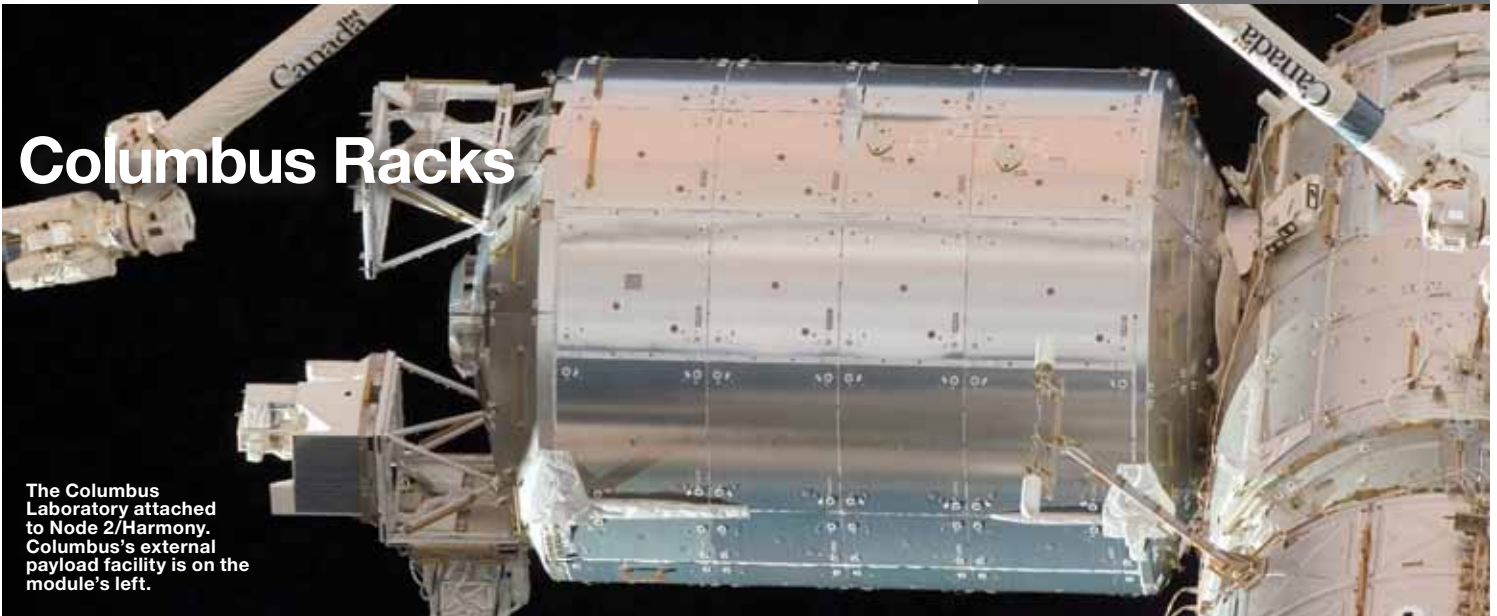
A multipurpose payload rack system that supports various fluid physics experiments.

Saibo Experiment Rack



A multipurpose payload rack system that sustains life science experiment units inside and supplies resources to them.

Columbus Racks



The Columbus Laboratory attached to Node 2/Harmony. Columbus's external payload facility is on the module's left.

EXPRESS Rack 3



Sub-rack-sized experiments with standard utilities such as power, data, cooling, and gases.

Microgravity Science Glovebox (MSG)



Provides a safe containment environment for research with liquids, combustion, and hazardous materials.

Muscle Atrophy Research and Exercise System (MARES)



Used for research on musculoskeletal, biomechanical, and neuromuscular human physiology.

Human Research Facility (HRF-1)



Enable researchers to study and evaluate the physiological, behavioral, and chemical changes induced by long-duration space flight.

Human Research Facility (HRF-2)



Enable researchers to study and evaluate the physiological, behavioral, and chemical changes induced by long-duration space flight.

Biological Experiment Laboratory (BioLab)



Used to perform space biology experiments on microorganisms, cells, tissue cultures, small plants, and small invertebrates.

European Drawer Rack (EDR)



Provides sub-rack-sized experiments with standard utilities such as power, data, and cooling.

European Physiology Module (EPM)



Investigates the effects of short- and long-duration space flight on the human body.

Fluid Science Laboratory (FSL)



A multi-user facility for conducting fluid physics research in microgravity conditions.

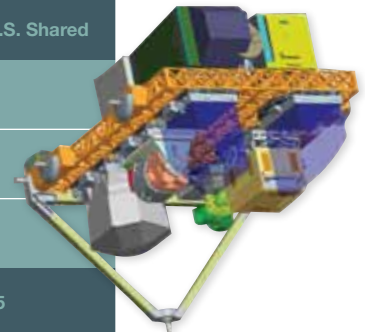
External Research Accommodations

External Earth and Space Science hardware platforms are located at various places along the outside of the ISS. Locations include the Columbus External Payload Facility (CEPF), Russian Service Module, Japanese Experiment Module Exposed Facility (JEM-EF), four EXPRESS Logistics Carriers (ELC), and the Alpha Magnetic Spectrometer (AMS). External facility investigations include those related to astronomy; Earth observation; and exposure to vacuum, radiation, extreme temperature, and orbital debris.



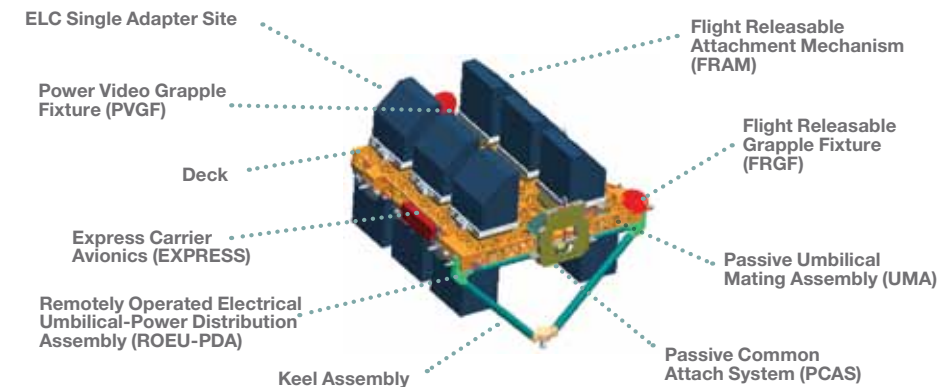
External Research Locations

External Unpressurized Attachment Sites	Stationwide	U.S. Shared
U.S. Truss	8	8
Japanese Exposed Facility	10	5
European Columbus Research Laboratory	4	2
Total	22	15



External Payload Accommodations

External payloads may be accommodated at several locations on the U.S. S3 and P3 Truss segments. External payloads are accommodated on an Expedite the Processing of Experiments to the Space Station racks (EXPRESS) Logistics Carrier (ELC). Mounting spaces are provided, and interfaces for power and data are standardized to provide quick and straightforward payload integration. Payloads can be mounted using the Special Purpose Dexterous Manipulator (SPDM), Dextre, on the ISS's robotic arm.



Express Logistics Carrier (ELC) Resources

Mass capacity	4,445 kg (9,800 lb)
Volume	30 m ³
Power	3 kW maximum, 113-126 VDC
Low-rate data	1 Mbps (MIL-STD-1553)
High-rate data	95 Mbps (shared)
Local area network	6 Mbps (802.3 Ethernet)

ELC Adapter Resources

Mass capacity	227 kg (500 lb)
Volume	1 m ³
Power	750 W, 113 to 126 VDC 500 W at 28 VDC per adapter
Thermal	Active heating, passive cooling
Low-rate data	1 Mbps (MIL-STD-1553)
Medium-rate data	6 Mbps (shared)

Kibo Exposed Facility Resources

Mass capacity	521.63 kg Standard Site 2494.8 kg Large Site
Volume	1.5 m ³
Power	3 kW max, 113-126 VDC
Thermal	3-6 kW cooling
Low-rate data	1 Mbps (MIL-STD-1553)
High-rate data	High Rate Data: 43 Mbps (shared) Ethernet: 10Mbps

Columbus External Payload Facility (CEPF) Resources

Mass capacity	226.8 kg
Volume	1 m ³
Power	2.5 kW max, 120 VDC (shared)
Thermal	Passive
Low-rate data	1 Mbps (MIL-STD-1553)
Medium-rate data	2 Mbps (shared) 10 Mbps (Ethernet)

Internal Research Accommodations

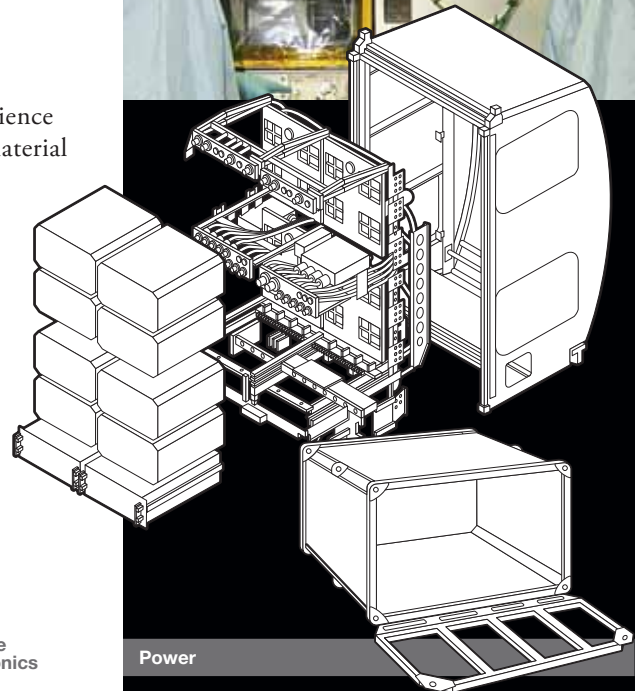
Several research facilities are in place aboard the ISS to support microgravity science investigations, including those in biology, biotechnology, human physiology, material science, physical sciences, and technology development.

Standard Payload Racks

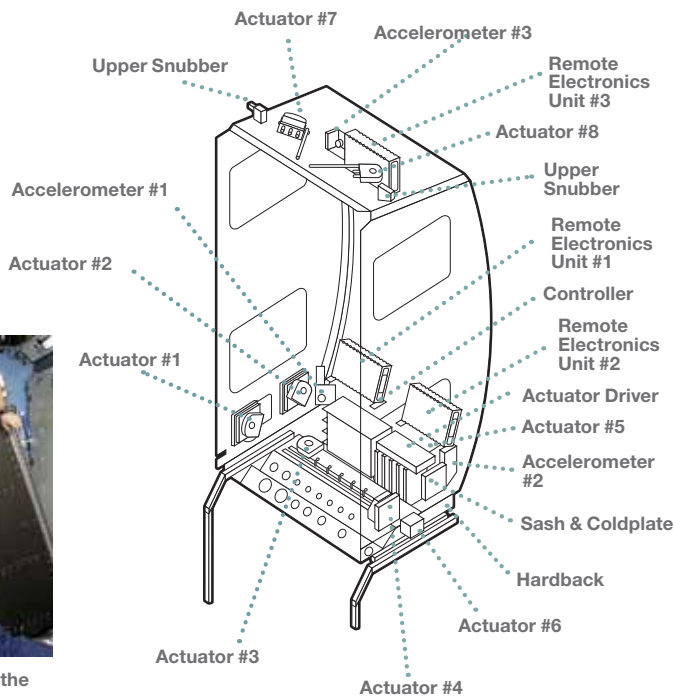
Research payloads within the U.S., European, and Japanese laboratories typically are housed in a standard rack, such as the International Standard Payload Rack (ISPR). Smaller payloads may fit in a Shuttle middeck locker equivalent and be carried in a rack framework.

Active Rack Isolation System (ARIS)

The ARIS is designed to isolate payload racks from vibration. The ARIS is an active electromechanical damping system attached to a standard rack that senses the vibratory environment with accelerometers and then damps it by introducing a compensating force.



Astronauts install a rack in the U.S. Laboratory.



Power
3, 6, or 12 kW, 114.5 to 126 voltage, direct current (VDC)

Data	
Low rate	MIL-STD-1553 bus 1 Mbps
High rate	100 Mbps
Ethernet	10 Mbps
Video	NTSC

Gases	
Nitrogen flow	0.1 kg/min minimum 517 to 827 kPa, nominal 1,379 kPa, maximum
Argon, carbon dioxide, helium	517 to 768 kPa, nominal 1,379 kPa, maximum

Cooling Loops	
Moderate temperature	16.1 to 18.3 °C
Flow rate	0 to 45.36 kg/h
Low temperature	3.3 to 5.6 °C
Flow rate	233 kg/h
Vacuum	
Venting	10 ⁻³ torr in less than 2 h for single payload of 100 L
Vacuum resource	10 ⁻³ torr

Research Rack Locations

International Pressurized Sites	Total by Module	U.S. Shared
U.S. Destiny Laboratory	13	13
Japanese Kibo Laboratory	11	5
European Columbus Laboratory	10	5
Total	34	23



Installation of a rack in the U.S. Lab prior to launch.



research guide

The ISS is an unprecedented technological and political achievement in global human endeavors to conceive, plan, build, operate, and utilize a research platform in space. It is the latest step in humankind's quest to explore and live in space.

As on-orbit assembly of the ISS is completed—including all international partner laboratories and elements—it has developed into a unique research facility capable of unraveling the mysteries of life on Earth. We can use the ISS as a human-tended laboratory in low-Earth orbit to conduct multidiscipline research in biology and biotechnology, materials and physical science, technology advancement and development, and research on the effects of long-duration space flight on the human body. The results of the research completed on the ISS may be applied to various areas of science, enabling us to improve life on this planet and giving us the experience and increased understanding to journey to other worlds.



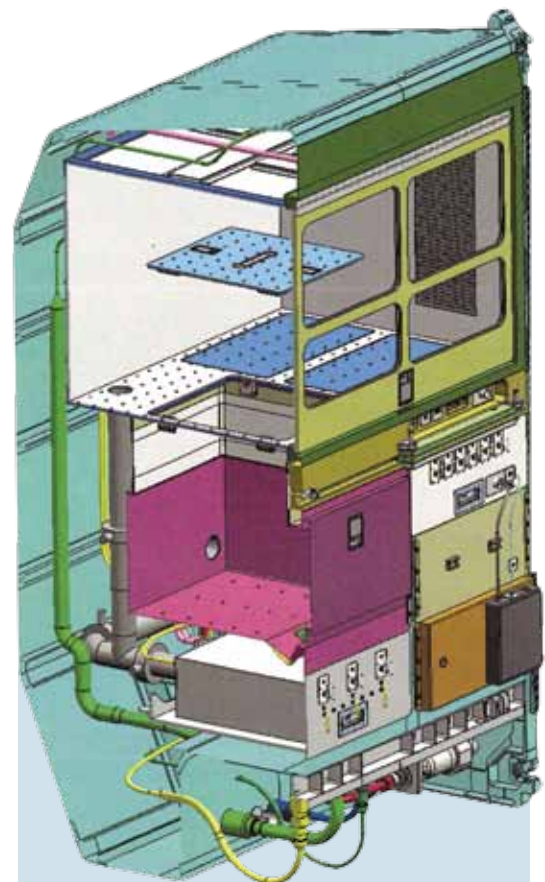
Multipurpose Facilities



European Drawer Rack (EDR) [ESA] is a multidiscipline facility to support up to seven modular experiment modules. Each payload will have its own cooling, power, data communications, vacuum, venting, and nitrogen supply. EDR facilitates autonomous operations of subrack experiments in a wide variety of scientific disciplines.

Protein Crystallization Diagnostics Facility (PCDF) is the first ESA experiment performed with the EDR rack. Its main science objectives are to study the protein crystal growth conditions by way of nonintrusive optical techniques like Dynamic Light Scattering (DLS), Mach-Zehnder Interferometry (MZI), and classical microscopy. Understanding how crystals grow in purely diffusive conditions helps define the best settings to get organic crystals as perfect as possible. Later on these crystals will be preserved and analyzed via X-rays on Earth to deduce the three-dimensional shape of proteins.

Expedite the Processing of Experiments to Space Station (EXPRESS) Racks [NASA] are modular multipurpose payload racks that store and support experiments aboard the ISS. The rack provides structural interfaces, power, data, cooling, water, and other items needed to operate the science experiments on the ISS. Experiments are exchanged in and out of the EXPRESS Rack as needed; some subrack multi-user facilities (like the European Modular Cultivation System [EMCS]) will remain in EXPRESS for the life of the ISS, while others are used for only a short period of time.



Multipurpose Small Payload Rack (MSPR) [JAXA] has two workspaces and one workbench and can hold equipment, supply power, and enable communication and video transmission. With such general characteristics, MSPR can be used in various fields of space environment use not only for science, but also for cultural missions.



Portable Glove Box (PGB) [ESA] is a small glovebox that can be transported around the ISS and used to provide two levels of containment for experiments in any laboratory module. Three levels of containment can be achieved by placing the PGB inside the larger volume of the MSG.

Gloveboxes provide containment of experiments, ensuring that hazardous materials do not float about the cabin. The Microgravity Science Glovebox (MSG) has been the most heavily used facility during ISS construction. In one short period in 2008, it was used for a combustion experiment, for a study of complex fluids, and to harvest plants. A wide variety of experiments will be using the versatile MSG accommodation and functional capabilities.



Microgravity Science Glovebox (MSG) [ESA, NASA] provides a safe environment for research with liquids, combustion, and hazardous materials on board the ISS. Crewmembers access the work area through ports equipped with rugged, sealed gloves.

A video system and data downlinks allow for control of the enclosed experiments from the ground. Built by ESA and operated by NASA, MSG is the largest glovebox flown in space.



Microgravity Experiment Research Locker/Incubator (MERLIN) [NASA] can be used as either a freezer, refrigerator, or incubator (between $-20.0\text{ }^{\circ}\text{C}$ to $48.5\text{ }^{\circ}\text{C}$) and has a volume of 4.17 L.





General Laboratory Active Cryogenic ISS Equipment Refrigerator (GLACIER) [NASA] serves as an on-orbit ultra-cold freezer (as low as $-165\text{ }^{\circ}\text{C}$) and has a volume of 11.35 L.



Minus Eighty-Degree Laboratory Freezer for ISS (MELFI) [ESA, NASA] is a refrigerator/freezer for biological and life science samples collected on the ISS. These ESA-built and NASA-operated freezers store samples at temperatures of $+4\text{ }^{\circ}\text{C}$ to as low as $-80\text{ }^{\circ}\text{C}$, and each has a volume of 175 L of samples.

EXPRESS Rack Designs

Over 50 percent of the capabilities of EXPRESS Racks are available for new research equipment. EXPRESS Racks are the most flexible modular research facility available on ISS and are used for NASA and international cooperative research.

	Available for future utilization		Facilities currently in use
	Systems hardware		Water-cooled payloads

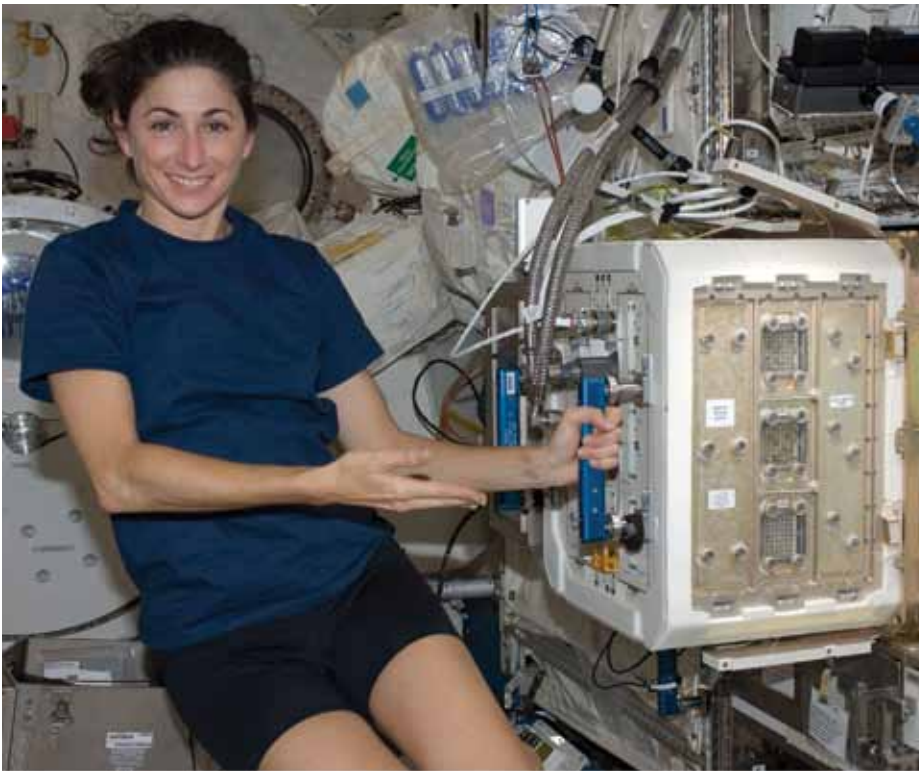


Biological Research

Biological Laboratory (BioLab) [ESA] is used to perform space biology experiments on microorganisms, cells, tissue cultures, small plants, and small invertebrates, and it will allow a better understanding of the effects of microgravity and space radiation on biological organisms. BioLab includes an incubator with a microscope, spectrophotometer, and two centrifuges to provide artificial gravity. It also has a glovebox and two cooler/freezer units.



Biotechnology Specimen Temperature Controller (BSTC) [NASA] includes a refrigerator, incubator, and cryo-drawer, as well as environmental and atmospheric control to grow and maintain mammalian cell cultures in microgravity.



Mice Drawer System (MDS) [NASA, ASI] is hardware provided by the Italian Space Agency (ASI) that uses a validated mouse model to investigate the genetic mechanisms underlying bone mass loss in microgravity. MDS is a multifunctional and multiuser system that allows experiments in various areas of biomedicine, from research on organ function to the study of the embryonic development of small mammals under microgravity conditions. Research conducted with the MDS is an analog to the human research program, which has the objective to extend the human presence safely beyond low-Earth orbit.



Advanced Biological Research System (ABRS) [NASA] is a single locker system with two growth chambers. Each growth chamber is a closed system capable of independently controlling temperature, illumination, and atmospheric composition to grow a variety of biological organisms including plants, microorganisms, and small arthropods (insects and spiders).

The first plant experiments in ABRS will include the first trees flown in space (willows for a Canadian study of cambium formation), and an American study will use green fluorescent proteins as environmental stress indicators.



Exposure Experiment (Expose) [ESA] is a multi-user facility accommodating experiments in the following disciplines: photo processing, photo-biology, and exobiology. Expose allows short- and long-term exposure of experiments to space conditions and solar UV radiation on the ISS. The Expose facilities are installed on the external surfaces of Zvezda service module and Columbus module.



Waving and Coiling of Arabidopsis Roots at Different g-levels (WAICO) was the first experiment conducted in BioLab. Plant growth is impacted by several factors (i.e., temperature, humidity, gravitropism, phototropism, and circumnutation). Shoots/stems and roots develop following complex phenomena at micro-/macroscopic levels. The goal of this experiment was to understand the interaction of circumnutation (the successive bowing or bending in different directions of the growing tip of the stems and roots) and gravitropism (a tendency to grow toward or away from gravity) in microgravity and 1-g of *Arabidopsis thaliana* wild type and an agravitropism mutant.



Kriogem-3M [Roscosmos] is a refrigerator-incubator used for stowage of biological samples and for the culture and incubation of bioreactors such as **Recomb-K**. Bioreactors are specialized hardware for growing cells, tissues, and microorganisms.



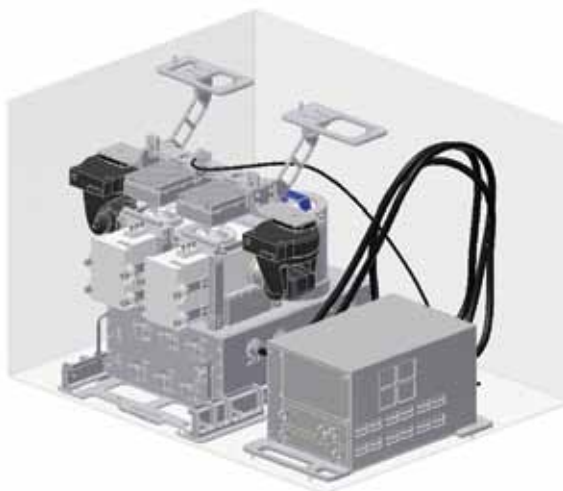
eOSTEO Bone Culture System [CSA] provides the right conditions to grow bone cells in microgravity. This culture system has been used successfully on U.S. Space Shuttle and Russian Foton recoverable orbital flights, and is also available for use in bone cell culture on ISS.

Understanding the cellular changes in bone cells in orbit could be key for understanding the bone loss that occurs in astronauts while they are in space.



Saibo Experiment Rack (Saibo) [JAXA] is a multipurpose payload rack system that sustains life science experiment units inside and supplies resources to them. Saibo consists of a Clean Bench, a glovebox with a microscope, and a **Cell Biology Experiment Facility (CBEF)**, which has incubators, a centrifuge, and sensors to monitor the atmospheric gases.

Saibo means "living cell." The first use of Saibo was for studies of the effects of radiation on immature immune cells.



Aquatic Habitat (AQH) [JAXA] enables breeding experiments with medaka or zebrafish in space, and those small freshwater fish have many advantages as one of the model animals for study. The AQH is composed of two aquariums, which have automatic feeding systems, LED lights to generate day/night cycle, and charge-coupled device (CCD) cameras for observation.



LADA Greenhouse [Roscosmos] – Since its launch in 2002, the LADA greenhouse has been in almost continuous use for growing plants in the Russian segment. It has supported a series of experiments on fundamental plant biology and space farming, growing multiple generations of sweet peas, wheat, tomatoes, and lettuce.

NASA and Roscosmos have used the LADA greenhouse in cooperative tests to determine the best ways to keep roots moist in space. Bioregenerative life support from photosynthesis may be an important component of future spacecraft systems.



European Modular Cultivation System (EMCS) [ESA, NASA] allows for cultivation, stimulation, and crew-assisted operation of biological experiments under well-controlled conditions (e.g., temperature, atmospheric composition, water supply, and illumination). It is being used for multi-generation experiments and studies of gravitational effects on early development and growth in plants and other small organisms.

The EMCS has two centrifuges, spinning at up to twice Earth's gravity. Different experiment containers can hold a variety of organisms, such as worms and fruit flies, as well as seeds and plants. The EMCS has already supported a number of plant growth experiments operated by ESA, NASA, and JAXA.



Commercial Generic Bioprocessing Apparatus (CGBA) [NASA] provides programmable, accurate temperature control—from cold stowage to a customizable incubator—for experiments that examine the biophysical and biochemical actions of microorganisms in microgravity. CGBA can be used in a wide variety of biological studies, such as protein crystal growth, small insect habitats, plant development, antibiotic-producing bacteria, and cell culture studies.

CGBA, operated by Bioserve Space Technologies, is a key facility being used by U.S. investigators as part of the ISS National Laboratory initiative.



Human Physiology Research



SLAMMD



Clinical Ultrasound



Refrigerated Centrifuge



SLAMMD and PFS are used by flight surgeons during periodic medical exams on the ISS. Understanding the gradual deconditioning of astronauts and cosmonauts during their stay on the ISS is critical for developing better exercise capabilities for exploration beyond Earth orbit.



Human Research Facility (HRF-1 and HRF-2) [NASA] enables human life science researchers to study and evaluate the physiological, behavioral, and chemical changes induced by long-duration space flight. HRF-1 houses medical equipment including a **Clinical Ultrasound**, the **Space Linear Acceleration Mass Measurement Device (SLAMMD)** for measuring on-orbit crewmember mass, devices for measuring blood pressure and heart function, and a **Refrigerated Centrifuge** for processing blood samples. The equipment is being used to study the effects of long-duration space flight on the human body. Researchers will use the ISS to understand the physiology and to test countermeasures that will prevent negative effects of space travel, and enable humans to travel beyond Earth orbit.

Techniques developed for using ultrasound technology on the ISS are now being used in trauma facilities to more rapidly assess serious patient injuries.

European Physiology Module (EPM) [ESA] is designed for investigating the effects of microgravity on short-term and long-duration space flights on the human body and includes equipment for studies in neuroscience, and in cardiovascular, bone, and muscle physiology, as well as investigations of metabolic processes. The cardiolab instrument was provided by the French Space Agency (CNES) and German Aerospace Center (DLR).



Anomalous Long Term Effects in Astronaut's Central Nervous System (ALTEA) [ASI, NASA, ESA] ALTEA is a helmet-shaped device holding six silicon particle detectors that has been used to measure the effect of the exposure of crewmembers to cosmic radiation on brain activity and visual perception, including astronauts' perceptions of light flashes behind their eyelids as a result of high-energy radiation. Because of its ability to be operated without a crewmember, it is also being used as a portable dosimeter to provide quantitative data on high-energy radiation particles passing into the ISS.

ALTEA-Dosi capabilities are also used to give additional information on the exposure of crewmembers to radiation during their stays on ISS for use in health monitoring. ALTEA-Shield will provide data about radiation shielding effects by a variety of special materials.

Pulmonary Function System (PFS) [ESA, NASA] is hardware developed collaboratively by ESA and NASA. It includes four components that are needed to make sophisticated studies of lung function by measuring respired gases in astronaut subjects. It includes two complimentary analyzers to measure the gas composition of breath, the capability to make numerous different measurements of lung capacity and breath volume, and a system to deliver special gas mixtures that allow astronauts to perform special tests of lung performance. ESA will also be operating a small portable version of the system (portable PFS) that can be used in the various laboratory modules.





The **Combined Operational Load Bearing External Resistive Exercise Treadmill (COLBERT)** [NASA] can collect data such as body loading, duration of session, and speed for each crewmember.

The **Advanced Resistive Exercise Device (ARED)** [NASA] is systems hardware that provides exercise capabilities to crewmembers on the ISS. The ARED also collects data regarding the parameters (loads, repetitions, stroke, etc.) associated with crew exercise and transmits it to the ground.

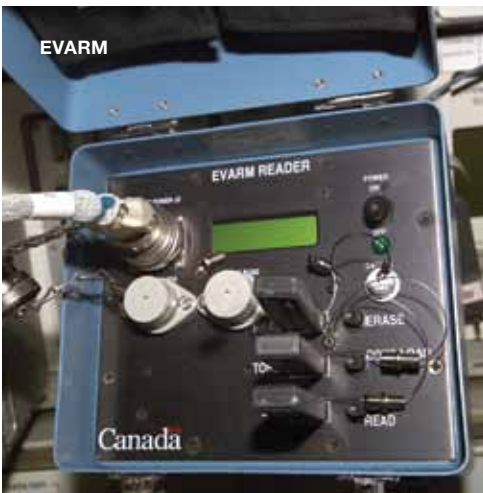
The **Cycle Ergometer with Vibration Isolation System (CEVIS)** [NASA] provides the ability for recumbent cycling to provide aerobic exercise as a countermeasure to cardiovascular deconditioning on orbit.

The second generation of exercise equipment used for daily exercise on board the ISS collects information on protocols and forces that are used as supplemental data for studies of muscle and bone loss and cardiovascular health during long-duration space flight.

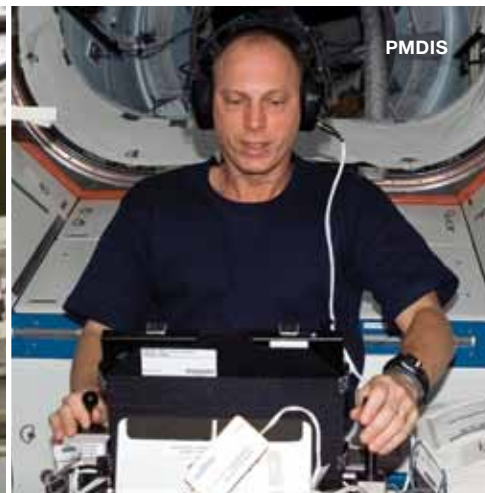
Percutaneous Electrical Muscle Stimulator (PEMS) [ESA] is a self-contained, locker-stowed item. Its purpose is to deliver electrical pulse stimulation to nonthoracic muscle groups of the human test subject, thereby creating contractile responses from the muscles. The PEMS supports neuromuscular research. It provides single pulses or pulse trains according to a preadjusted program.



Muscle Atrophy Research Exercise System (MARES) [ESA] will be used for research on musculoskeletal, biomechanical, and neuromuscular human physiology to better understand the effects of microgravity on the muscles. This instrument is capable of assessing the strength of isolated muscle groups around joints by controlling and measuring relationships between position/velocity and torque/force as a function of time.



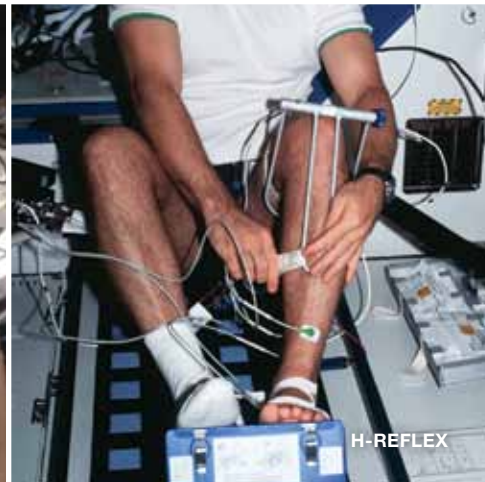
EVARM



PMDIS

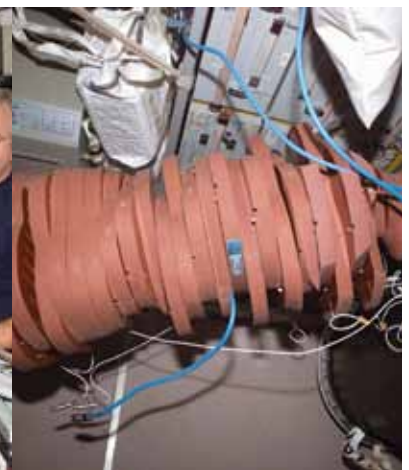
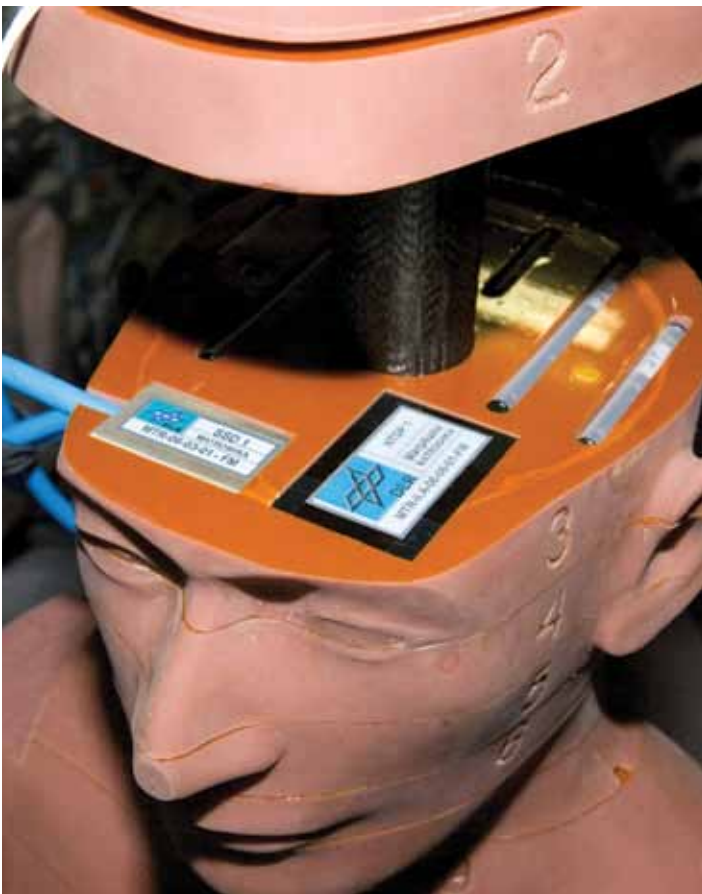


BISE



H-REFLEX

Human Research Hardware [CSA] is used cooperatively with other international hardware for better understanding of the physiological responses to space flight. The hardware includes radiation dosimeters (**Extravehicular Activity Radiation Monitoring [EVARM]**) and hardware and software for studying hand-eye coordination and visual perception (**Perceptual Motor Deficits in Space [PMDIS]**), **Bodies In the Space Environment [BISE]** and neurophysiology (**Effects of Altered Gravity on Spinal Cord Excitability [H-Reflex]**).



Measuring Radiation Hazards in Space (Matryoshka) [ESA, Roscosmos, NASA, JAXA] is a series of investigations to measure radiation doses experienced by astronauts in space outside (MTR-1) and at various locations inside (MTR-2) the ISS. Matryoshka uses a mannequin of a human torso made of plastic, foam, and a real human skeleton. The torso is equipped with dozens of radiation sensors that are placed in strategic locations throughout its surface and interior to measure how susceptible different organs and tissue may be to radiation damage experienced by astronauts in space. Research institutes from around the world have collaborated and shared data from the project. The results will give the radiation dose distribution inside a human phantom torso for a better correlation between skin and organ dose and for better risk assessment in future long-duration space flight.

Participants from 10 countries provided dosimeters and other components of Matryoshka, making it one of the largest multinational collaborative investigations on the ISS. The Matryoshka program started in 2004 and will incrementally continue for some years.



Weightless Adaptation

Human Life Research [Roscosmos]

includes a variety of devices and systems designed to study human life in space. Components of the system of equipment include the Cardiovascular System Research Rack, Weightlessness Adaptation Study Kit, Immune System Study Kit, and Locomotor System Study Facility.



Locomotor System



Human Research Hardware [JAXA] includes a portable **Digital Holter ECG** recorder for 24-hour electrocardiogram monitoring of cardiovascular and autonomic function of the astronauts.

The recorded data are downlinked through the **Multi-Protocol Converter (MPC)** and crew **Passive Dosimeter for Lifescience Experiment in Space (PADLES)**, which is a passive dosimeter that records the personal dose of the astronauts. The dose records are used to assess a radiation exposure limit of each astronaut.

Human physiology research is coordinated by an internal working group to coordinate experiments and share data. An astronaut or cosmonaut can participate in as many as 20 physiology experiments during his or her stay on the ISS.

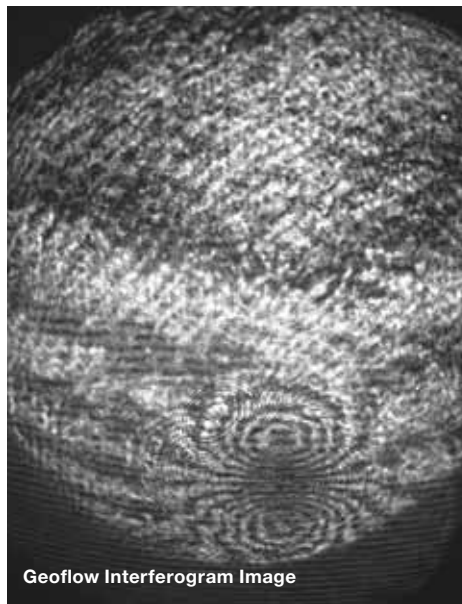


Hand Posture Analyser (HPA) [NASA, ASI] is composed of the Handgrip Dynamometer/Pinch Force Dynamometer, the Posture Acquisition Glove and the Inertial Tracking System (ITS) for the measurement of finger position and upper limb kinematics. The HPA examines the way hand and arm muscles are used differently during grasping and reaching tasks in weightlessness.

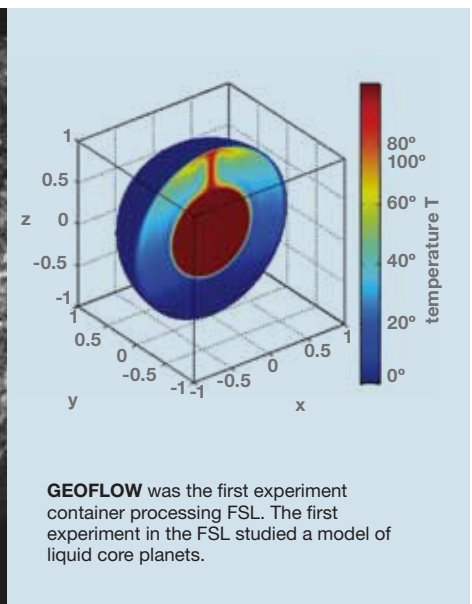
Physical Science and Materials Research



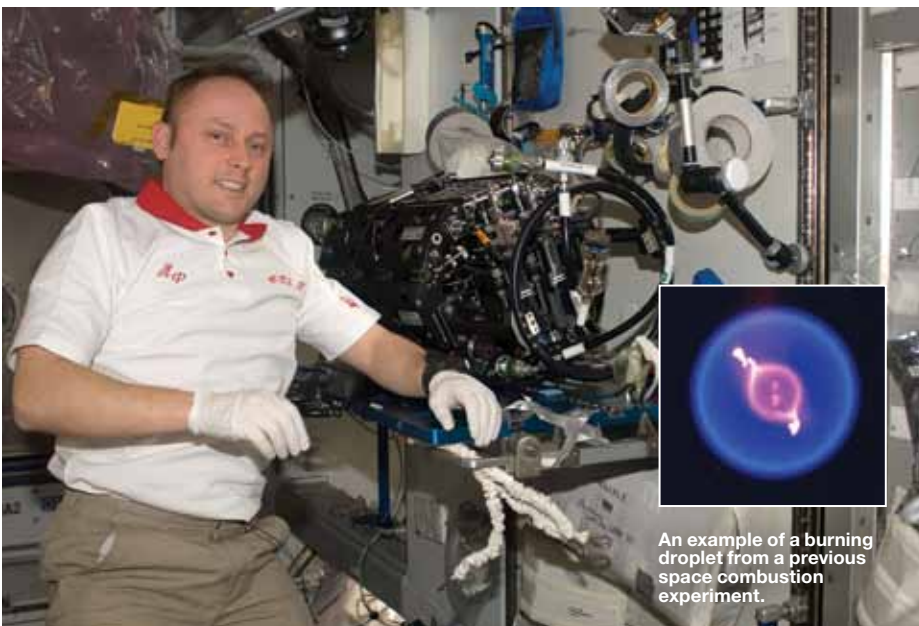
Fluid Science Laboratory (FSL) [ESA] is a multi-user facility for conducting fluid physics research in microgravity conditions. The FSL provides a central location to perform fluid physics experiments on board the ISS that will give insight into the physics of fluids in space, including aqueous foams, emulsions, convection, and fluid motions. Understanding how fluids behave in microgravity will lead to development of new fluid delivery systems in future spacecraft design and development.



Geoflow Interferogram Image



GEOFLOW was the first experiment container processing FSL. The first experiment in the FSL studied a model of liquid core planets.

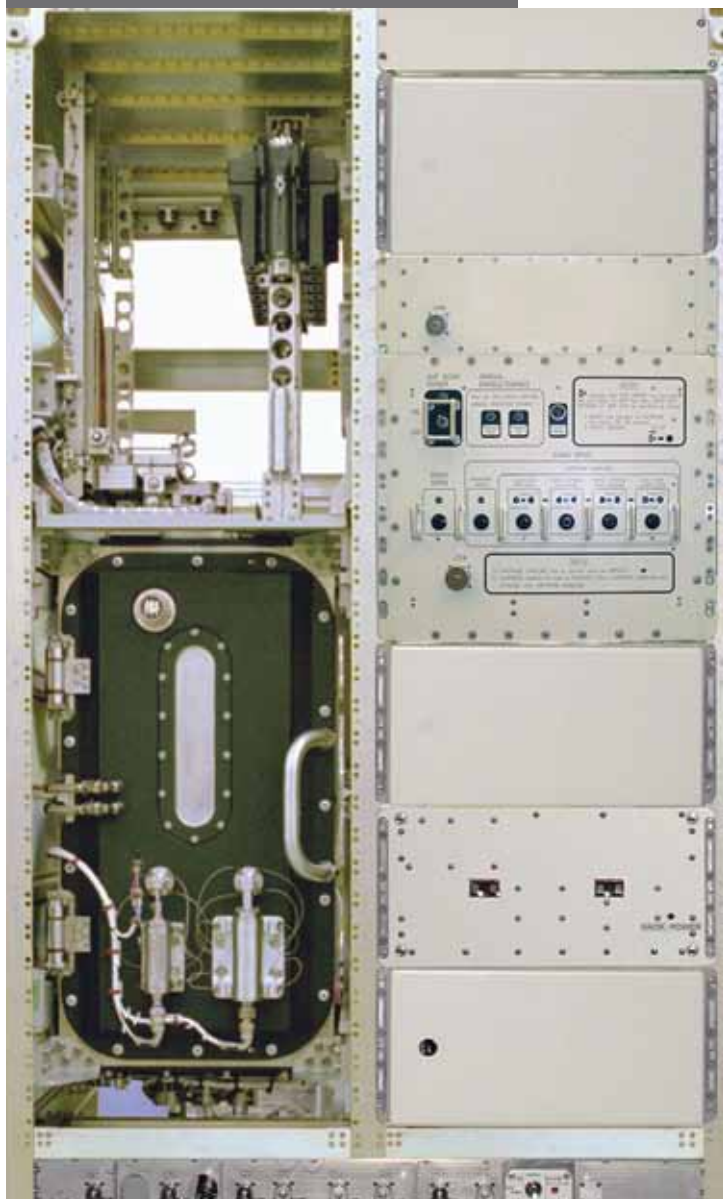


An example of a burning droplet from a previous space combustion experiment.

The Multi-User Droplet Combustion Apparatus—Flame Extinguishment Experiment (MDCA-FLEX) [NASA] creates droplets of fuel that ignite while suspended in a containment chamber.



Combustion Integrated Rack (CIR) [NASA] is used to perform sustained, systematic combustion experiments in microgravity. It consists of an optics bench, a combustion chamber, a fuel and oxidizer management system, environmental management systems, and interfaces for science diagnostics and experiment-specific equipment, as well as five different cameras to observe the patterns of combustion in microgravity for a wide variety of gases and materials.



Kobairo Rack with Gradient Heating Furnace (GHF) [JAXA] is an electrical furnace to be used for generating high-quality crystals from melting materials. It consists of a vacuum chamber and three independently movable heaters, which can realize high temperature gradient up to 150 °C/cm.



Fluids Integrated Rack (FIR) [NASA] is a complementary fluid physics research facility designed to accommodate a wide variety of microgravity fluid experiments and the ability to image these experiments. The FIR features a large user-configurable volume for experiments. The FIR provides data acquisition and control, sensor interfaces, laser and white light sources, advanced imaging capabilities, power, cooling, and other resources. The FIR will host fluid physics investigations into areas such as complex fluids (colloids, gels), instabilities (bubbles), interfacial phenomena (wetting and capillary action), and phase changes (boiling and cooling). Fluids under microgravity conditions perform differently than those on Earth. Understanding how fluids react in these conditions will lead to improved designs on fuel tanks, water systems, and other fluid-based systems.

The FIR includes the Light Microscopy Module (LMM). The LMM is a remotely controllable (commanded from the ground), automated microscope that allows flexible imaging (bright field, dark field, phase contrast, etc.) for physical and biological experiments.



Ryutai Experiment Rack (Ryutai) [JAXA] is a multipurpose payload rack system that supports various fluid physics experiments. Ryutai consists of four sub-rack facilities: **Fluid Physics Experiment Facility (FPEF)**; **Solution Crystallization Observation Facility (SCOF)**; **Protein Crystallization Research Facility (PCRF)**; and **Image Processing Unit (IPU)**. Ryutai enables teleoperations of the experiments providing the electrical power, ground command and telemetry monitoring, water cooling, and gas supply to those sub-rack facilities.

Ryutai means “fluid.” The JAXA experiment Ice Crystal examines the factors that lead to the pattern formation in ice crystals in microgravity.



Materials Science Research Rack (MSRR-1) [ESA, NASA] provides a powerful, multi-user **Materials Science Laboratory (MSL)** in the microgravity environment of the ISS and can accommodate studies of many different types of materials. Experiment modules that contain metals, alloys, polymers, semiconductors, ceramics, crystals, and glasses can be studied to discover new applications for existing materials and new or improved materials (crystal growth, longer polymer chains, and purer alloys). MSRR will enable this research by providing hardware to control the thermal, environmental, and vacuum conditions of experiments; monitoring experiments with video; and supplying power and data handling for specific experiment instrumentation.

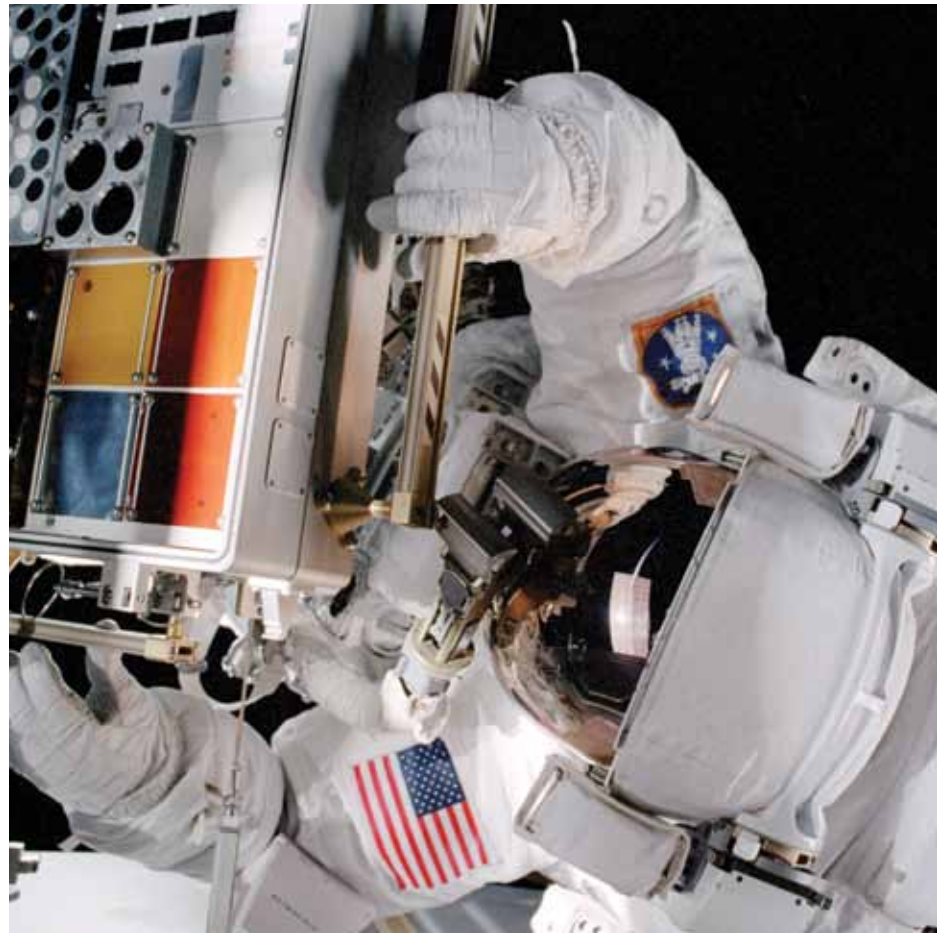
Sample Cartridge Assembly



Experiments in the **MSRR** are coordinated by international teams that share different parts of the samples. There are 25 investigators on 3 research teams participating in the first of these investigations. **MSL—Columnar-to-Equiaxed Transition in Solidification Processing and Microstructure Formation in Casting of Technical Alloys under Diffusive (MSL-CETSOL)** and **Magnetically Controlled Convective Conditions (MICAST)** are two investigations that support research into metallurgical solidification, semiconductor crystal growth (Bridgman and zone melting), and measurement of thermo-physical properties of materials.



Device for the study of Critical Liquids and Crystallization (DECLIC) [CNES, NASA] is a multi-user facility developed by the ESA-member agency Centre National d'Études Spatiales (French Space Agency, [CNES]) and flown in collaboration with NASA. It was designed to conduct experiments in the fields of fluid physics and materials science. A special insert allows the study of both ambient-temperature critical point fluids and high-temperature super-critical fluids. Another class of insert will study the dynamics and morphology of the fronts that form as a liquid material solidifies.



Materials International Space Station Experiment (MISSE) [NASA] is a series of external exchangeable test beds for studying the durability of materials such as optics, sensors, electronics, communications devices, coatings, and structural materials. To date, a total of seven different MISSE experiments have been attached to the outside of the ISS and evaluated for the effects of atomic oxygen, vacuum, solar radiation, micrometeorites, direct sunlight, and extremes of heat and cold. This experiment allows the development and testing of new materials to better withstand the rigors of space environments. Results will provide a better understanding of the durability of various materials when they are exposed to such an extreme environment. Many of the materials may have applications in the design of future spacecraft.

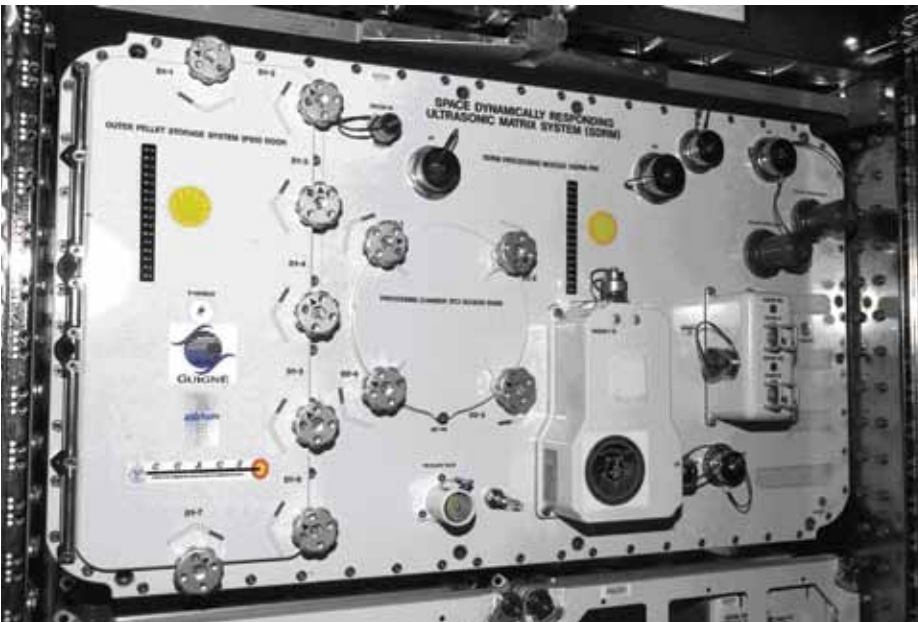
Results from MISSE tests have led to changes in materials used in dozens of spacecraft built over the last 5 years.



Super-High temperature Synthesis in space (SHS) [Roscosmos] This experiment is designed to develop a very interesting field of material science in space for fabrication and repair (welding, joining, cutting, coating, near-net-shape production, etc.) in microgravity and even on the Moon and other planets. Russian scientists have a very good collaboration in this field of investigation on the ISS with other partners (Europe, Japan, Canada). This process is a combination of several gravity-affected physical and chemical processes, operating at temperatures of synthesis up to 3,000 K.



Replaceable Cassette-Container (SKK or CKK) [Roscosmos] is mounted on the outside of the ISS to test materials that are directly exposed to the harsh environment of space. CKKs are detachable cassette containers that measure the level and composition of contamination and monitor the change in operating characteristics for samples of materials from the outside surfaces of the ISS Russian segment. The CKK is a two-flap structure and consists of a casing and spool holders containing samples of materials of the outside surfaces of the ISS Russian segment modules, which are exposed within the cassettes.



Space Dynamically Responding Ultrasonic Matrix System (SpaceDRUMS) [NASA]

will provide a suite of hardware capable of facilitating containerless advanced materials science, including combustion synthesis and fluid physics. SpaceDRUMS uses ultrasound to completely suspend a baseball-sized solid or liquid sample during combustion without the materials ever contacting the container walls. Such advanced ceramics production may have applications in new spacecraft or extraterrestrial outposts, such as bases on the Moon.

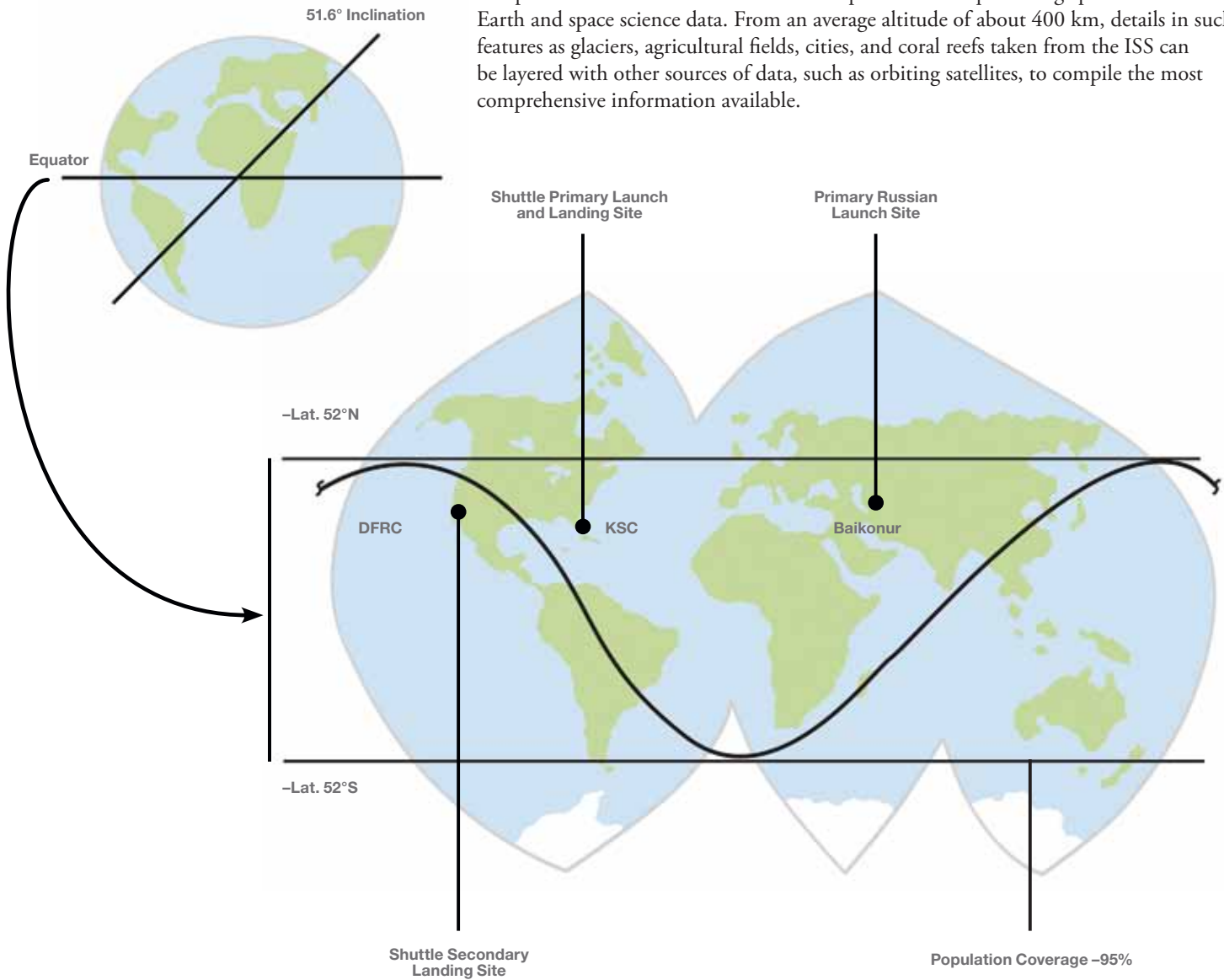


Bar and Expert Experiments [Roscosmos]

use a unique set of instruments for temperature cartography, ultrasonic probing, and pyro-endoscopic analysis of potentially dangerous places on board the ISS. Zones of possible formation of condensation have been revealed, and potential corrosion damage has been evaluated.

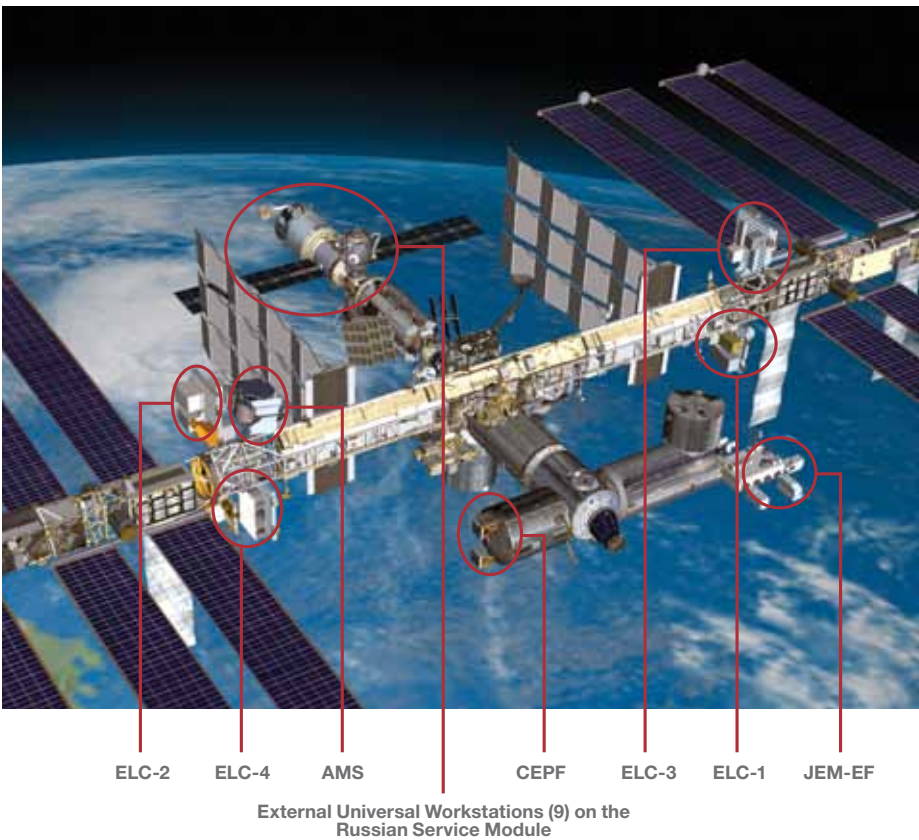
Earth and Space Science

The presence of the ISS in low-Earth orbit provides a unique vantage point for collecting Earth and space science data. From an average altitude of about 400 km, details in such features as glaciers, agricultural fields, cities, and coral reefs taken from the ISS can be layered with other sources of data, such as orbiting satellites, to compile the most comprehensive information available.



Diatomia [Roscosmos] is an investigation aimed at the detection and study of ocean bioproductivity. Experiment "Seiner" is targeted on monitoring of ocean fish-rich areas and on communication with fishing boats.

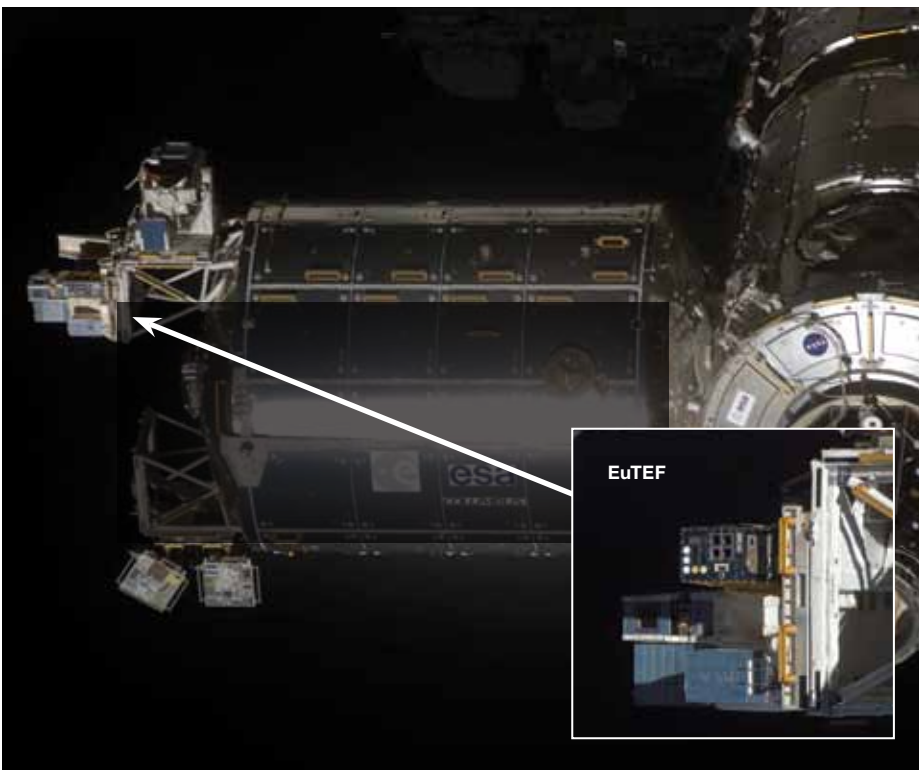




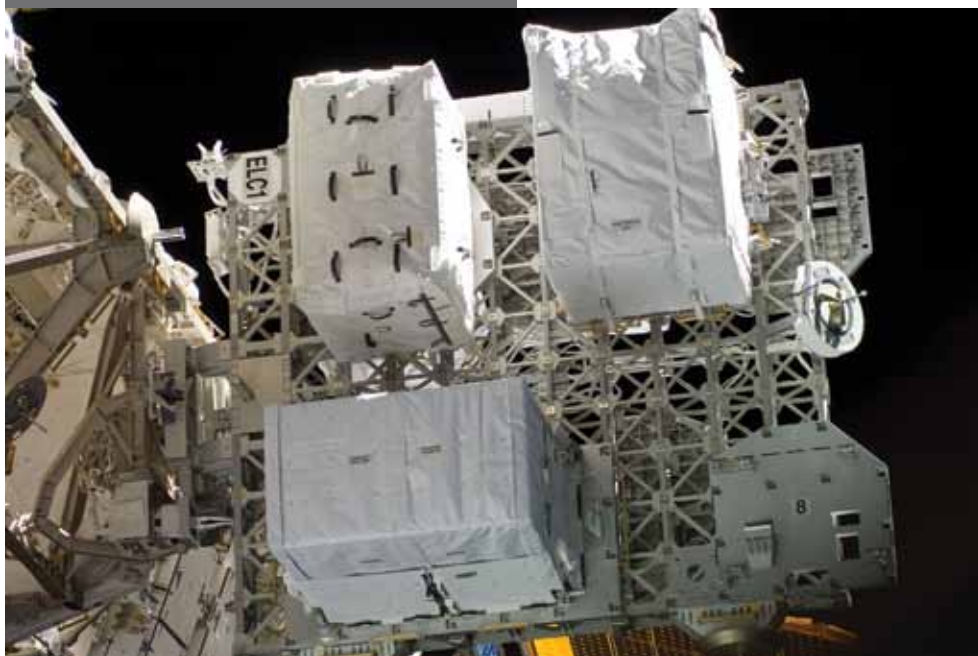
External Earth and space science hardware platforms are located at various places along the outside of the ISS. Locations include the Columbus External Payload Facility (CEPF), Russian Service Module, Japanese Experiment Module Exposed Facility (JEM-EF), four EXPRESS Logistic Carriers (ELC) and the Alpha Magnetic Spectrometer (AMS).



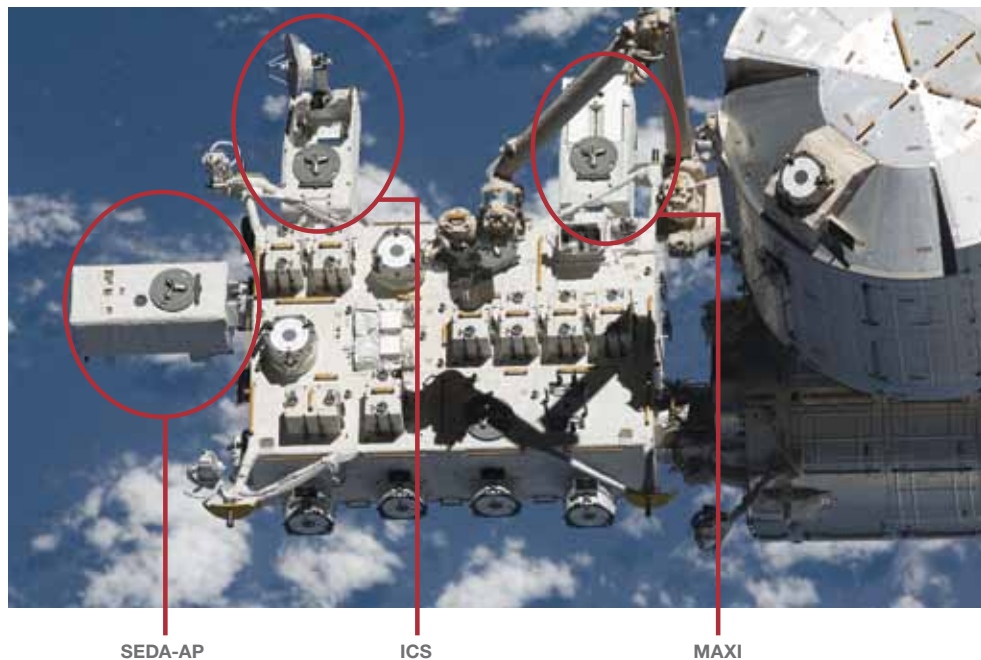
Columbus-External Payload Facility (Columbus-EPF) [ESA] provides four powered external attachment site locations for scientific payloads or facilities and is being used by ESA and NASA. The first two European payloads on Columbus-EPF are major multi-user facilities in themselves. **EuTEF** (European Technology Exposure Facility) is a set of nine different instruments and samples to support multidisciplinary studies of the ISS external environment, from radiation and space environment characterization to organic and technology materials exposure. **Solar** (Sun Monitoring on the External Payload Facility) is a triple spectrometer observatory that is currently measuring solar spectral irradiance. Knowledge of the solar energy irradiance into Earth's atmosphere and its variations is of great importance for atmospheric modeling, atmospheric chemistry, and climatology.



Two external facilities, **EuTEF** and **Solar**, provide sites for a variety of external material science and solar research experiments. In the future, the ACES payload with two high-precision atomic clocks and the **Atmosphere Space Interaction Monitor (ASIM)** will be deployed on CEPF.



Expedite the Processing of Experiments to the Space Station (EXPRESS) Logistics Carrier (ELC) [NASA] is designed to support external payloads mounted to the the ISS trusses, as well as store external spares (called Orbital Replacement Units) needed over the life of the ISS. Two ELCs are currently on board the ISS, and two additional ELCs will be delivered as part of the final assembly missions. Two ELCs are attached to the starboard truss 3 (S3), and two ELCs are attached to the port truss 3 (P3). Attaching at the S3/P3 sites enables a variety of views such as zenith (deep space) or nadir (Earthward) direction with a combination of ram (forward) or wake (aft) pointing that allows for many possible viewing opportunities.



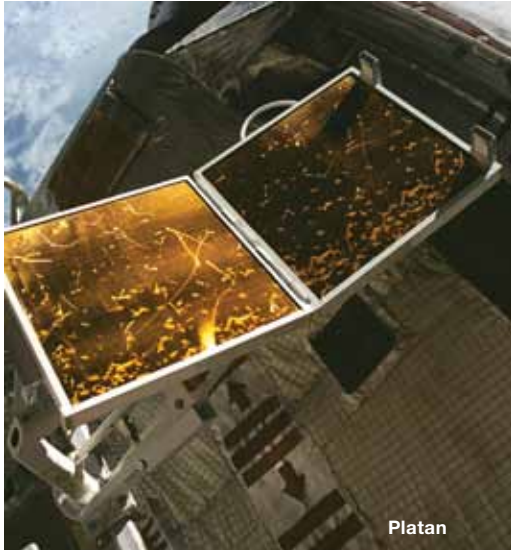
JEM Exposed Facility (JEM-EF) [JAXA] is an unpressurized pallet structure attached to the Japanese Experiment Module (JEM), Kibo. This external platform will be used for research in areas such as communications, space science, engineering, materials processing, and Earth observation. The **ICS** (Inter-Orbit Communication System) is used to downlink data to Earth.

The first JAXA experiments for the JEM-EF are **SEDA-AP** (Space Environment Data Acquisition equipment-Attached Payload), which measures the space environment around the ISS), **MAXI** (Monitor of All-sky X-ray Image), an instrument to monitor the X-ray sources in space), and **SMILES** (Superconducting Submillimeter-wave Limb-emission Sounder), which enables global observation of trace gases in the stratosphere.



Earth Resources Sensing and Geophysics Instruments [Roscosmos] are used in studies of geophysics, natural resources, and ecology. **Fialka** is an ultraviolet imager and spectrometer used to study radiation emitted by reactions of propulsion system exhaust products from ISS, Progress, and Soyuz vehicles with atomic oxygen. It is also used to study the spatial distribution and emission spectra of atmospheric phenomena such as airglow. **Rusalka** is a microspectrometer for collecting detailed information on observed spectral radiance in the near IR waveband for measurement of greenhouse gas concentrations in the Earth atmosphere.

The Alpha Magnetic Spectrometer (AMS-02) [NASA] is a state-of-the-art particle physics detector constructed, tested, and operated by an international team composed of 60 institutes from 16 countries and organized under United States Department of Energy (DOE) sponsorship. The AMS-02 will use the unique environment of space to advance knowledge of the universe and lead to the understanding of the universe's origin by searching for antimatter and dark matter and measuring cosmic rays. As the first long-duration magnetic spectrometer in space, AMS-02 will collect information from cosmic sources emanating from stars and galaxies millions of light-years beyond the Milky Way.



Cosmic Ray Detectors and Ionosphere Probes [Roscosmos] are important for studies of cosmic rays and the low-Earth orbit environment. **Platan** is an external detector for cosmic rays, **BTN** is an external detector measuring neutron flux, and **Vsplek** is an external detector for gamma rays and high-energy charged particles. Two packages, **Impulse** and **Obstanovka**, include ionosphere probes and pulsed plasma source (**IPI-100**) for making measurements of the ionosphere parameters and plasma-wave characteristics and are planned for launch and mounting outside the ISS in the future.



Window Observational Research Facility (WORF) [NASA] provides a facility for Earth science research using the Destiny optical-quality science window on the ISS. WORF provides structural hardware, avionics, thermal conditioning, and an optical-quality window to support a wide variety of remote sensing instruments operating in the shirtsleeve environment of the pressurized ISS laboratory.

Destiny features an Earth observation window with the highest quality optics ever flown on a human-occupied spacecraft. The sensing instrument to be used in WORF, **ISSAC (International Space Station Agricultural Camera)** is an infrared camera that will take frequent images of growing crops to help farmers manage their lands.

The Global Transmission Services (GTS) Experiment is continuously operating within an ESA/Russian cooperation on the Russian segment of the ISS and is testing the receiving conditions of a time and data signal for dedicated receivers on the ground. The time signal has special coding to allow the receiver to determine the local time anywhere on Earth. The main objectives of the experiment are to verify the performance and accuracy of a time signal transmitted to Earth's surface; the signal quality and data rates achieved on the ground; and measurement of disturbing effects such as Doppler shifts, multipath reflections, shadowing, and elevation impacts.

Expedition 20 represented a milestone on board the ISS. It was the first time each international partner had a representative on board the station at the same time.

Frank De Winne
Belgium
ESA

Roman Romanenko
Russia
Roscosmos

Gennady Padalka
Russia
Roscosmos



Michael Barratt
United States
NASA

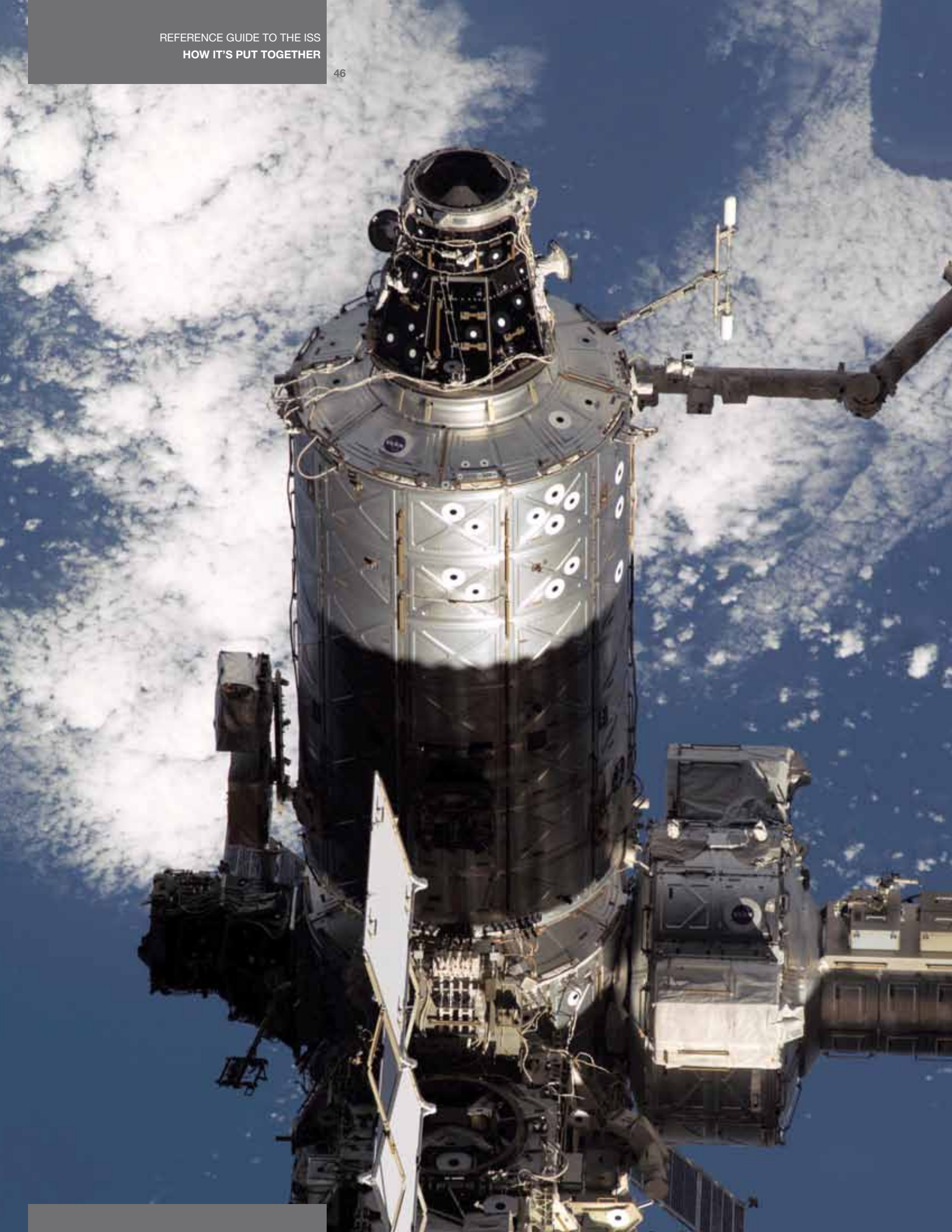
Robert Thirsk
Canada
CSA

Koichi Wakata
Japan
JAXA

how it's put together

The International Space Station (ISS) was an experiment in design, development, and assembly of an orbital space facility. Its modular design was dictated in part by the launch vehicle payload bay size and the requirement to make system components maintainable, replaceable, and able to fit through a hatch.

The ISS modules serve as a habitat for its crew and provide ports for docking and berthing resupply ships. The ISS functions as a microgravity and life sciences laboratory, test bed for new technologies, and platform for Earth and celestial observations.



U.S. Laboratory Module Destiny

NASA/Boeing

The U.S. Laboratory Module, called Destiny, is the primary research laboratory for U.S. payloads, supporting a wide range of experiments and studies contributing to health, safety, and quality of life for people all over the world.

Science conducted on the ISS offers researchers an unparalleled opportunity to test physical processes in the absence of gravity. The results of these experiments will allow scientists to better understand our world and ourselves and prepare us for future missions. Destiny provides internal interfaces to accommodate 24 equipment racks for accommodation and control of ISS systems and scientific research.



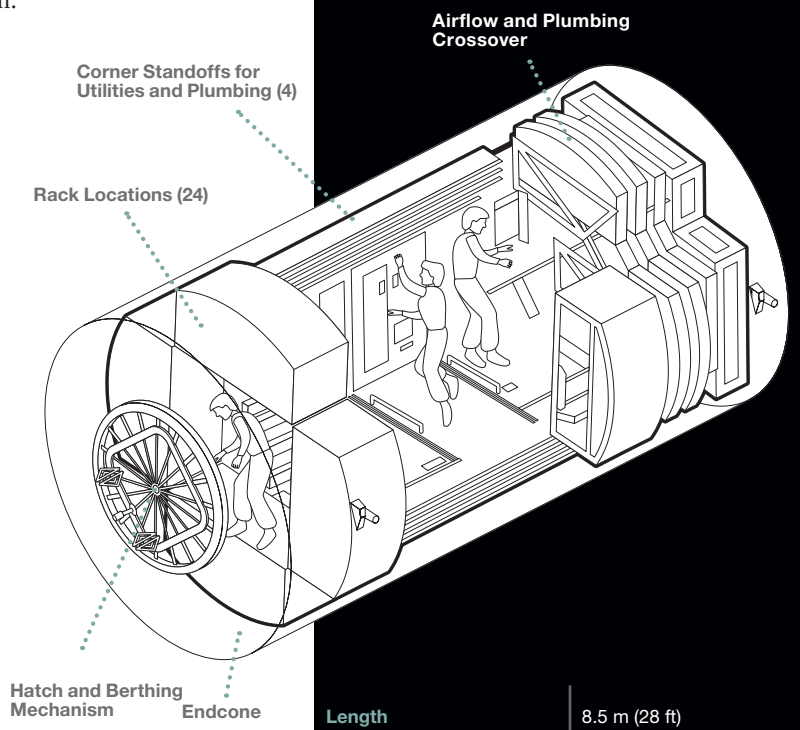
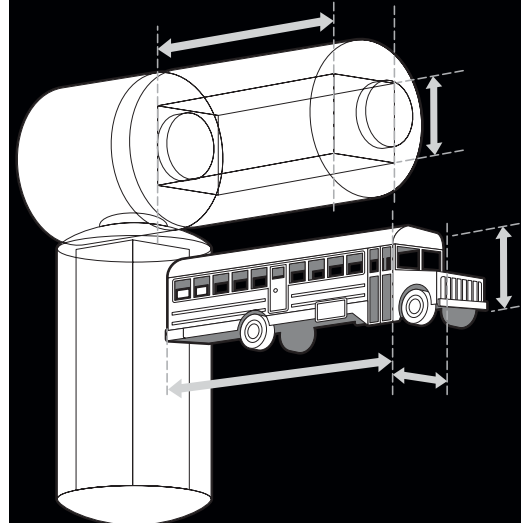
Doug Wheelock as he retrieves 2D Nano Template sample bags from the Minus Eighty Laboratory Freezer for ISS (MELFI) in U.S. Laboratory Destiny.



Astronaut Nicole Stott uses a communication system while installing the Light Microscopy Module (LMM) Spindle Bracket Assembly in the Fluids Integrated Rack (FIR) in the Destiny laboratory of the ISS.



Alexander Skvortsov in U.S. Laboratory Destiny.



Length	8.5 m (28 ft)
Length with attached Common Berthing Mechanism (CBM)	9.2 m (30.2 ft)
Width	4.3 m diameter (14 ft)
Mass	14,515 kg (32,000 lb) 24,023 kg (52,962 lb) with all racks and outfitting
Exterior	Aluminum, 3 cylindrical sections, 2 endcones
Number of racks	24 (13 scientific and 11 system)
Windows	1, with a diameter of 50.9 cm (20 in)
Launch date	February 7, 2001 STS-98 5A

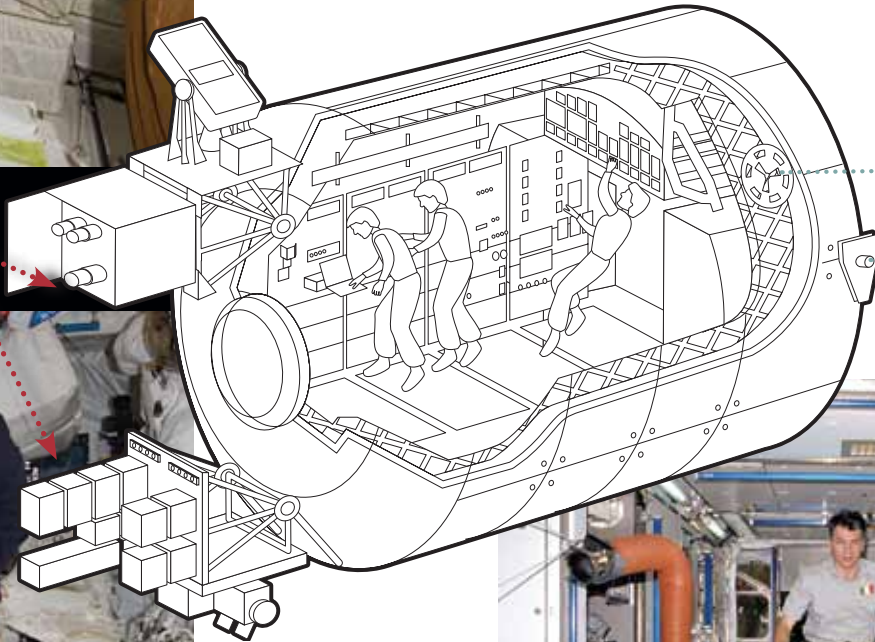
European Research Laboratory Columbus

European Space Agency (ESA)/European Aeronautic
 Defence and Space Co. (EADS) Space Transportation

The Columbus Research Laboratory is Europe's largest contribution to the construction of the ISS. It supports scientific and technological research in a microgravity environment. Columbus is a multifunctional pressurized laboratory permanently attached to Node 2 of the ISS. Astronauts will carry out experiments in materials science, fluid physics, life science, and technology.



Crewmember Tracy Caldwell working with stowage in Columbus.



External Payload Facility

Power Data Grapple Fixture (PDGF) for maneuvering by remote manipulator system

Trunnion Pin for mounting in Space Shuttle



Columbus interior with ESA astronaut Frank De Winne.



ESA Astronaut Paolo A. Nespoli, posing in the Columbus module with a model of Columbus floating in front of him.

Length	6.9 m (22.6 ft)
Diameter	4.5 m (14.7 ft)
Mass without payload with payload	10,300 kg (22,700 lb) 19,300 kg (42,550 lb)
Launch date	February 7, 2008 STS-122 1E
Racks	10 International Standard Payload Racks (ISPRs)



Columbus attached to the ISS.

Japanese Experiment Module Kibo (Hope)

Japan Aerospace Exploration Agency (JAXA)/Mitsubishi Heavy Industries, Ltd.

The Japanese Experiment Module (JEM), known as “Kibo” (pronounced key-bow), which means “hope” in Japanese, is Japan’s first human-rated space facility and the Japan Aerospace Exploration Agency’s (JAXA’s) first contribution to the ISS program.

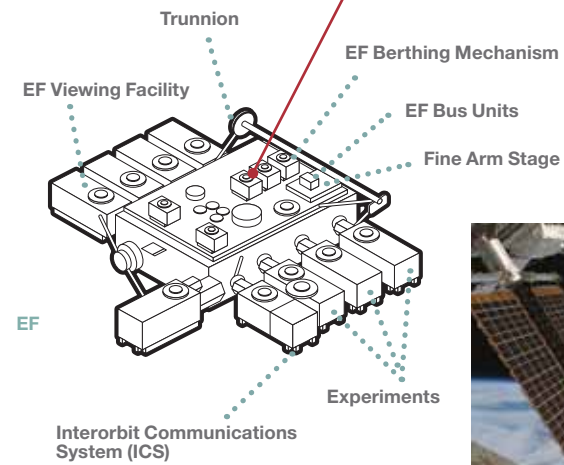
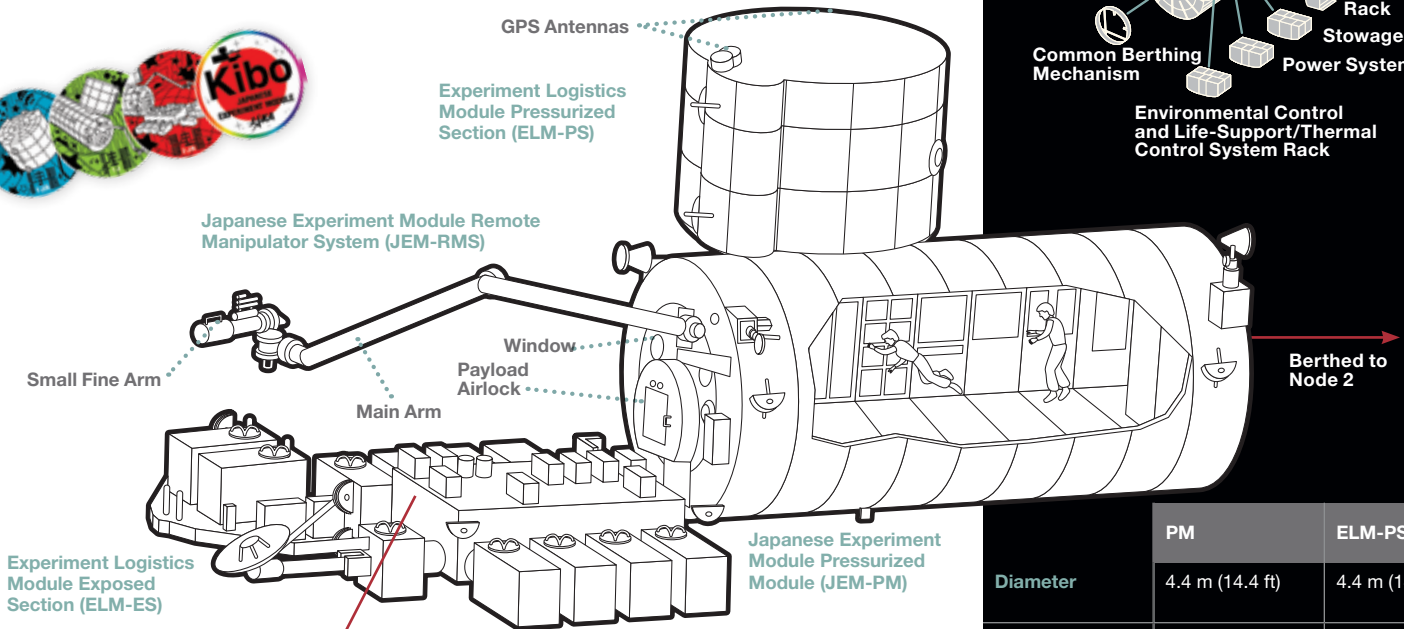
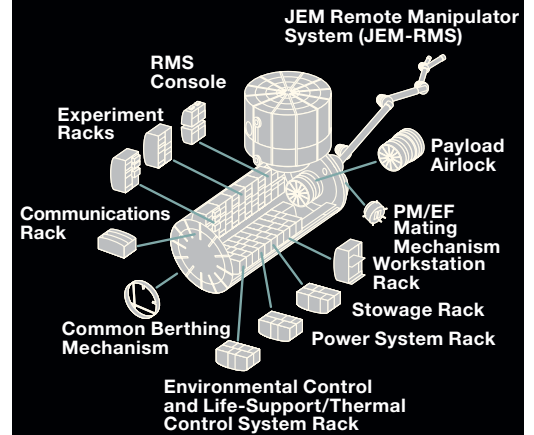
Kibo was designed and developed with a view to conducting scientific research activities on orbit. In Kibo, a maximum of four astronauts can perform experimental activities.

Currently, educational, cultural, and commercial uses of Kibo are also planned. Thus, as a part of the ISS, Kibo will provide extensive opportunities for utilization of the space environment.

Resources necessary for Kibo’s on-orbit operation, such as air, power, data, and cooling fluid, are provided from the U.S. segment of the ISS.



JEM Pressurized Module



	PM	ELM-PS
Diameter	4.4 m (14.4 ft)	4.4 m (14.4 ft)
Length	11.2 m (36.7 ft)	3.9 m (12 ft)
Mass	15,900 kg (35,050 lb)	4,200 kg (9,260 lb)
Launch date	May 31, 2008 STS-124 1J	March 11, 2008 STS-123 1J/A

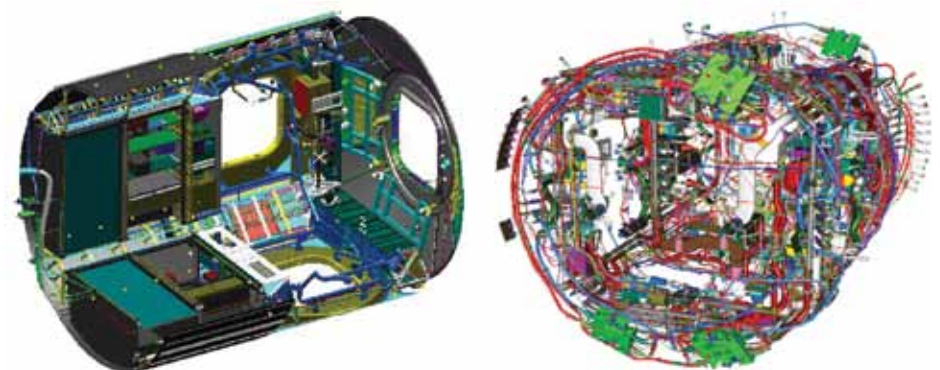
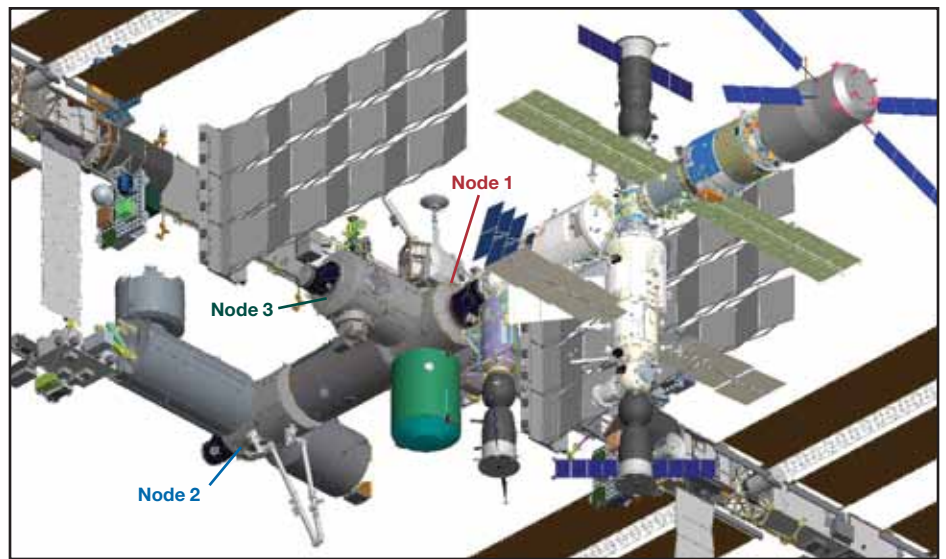
EF	
Dimensions	5.6 × 5 × 4 m (18.4 × 16.4 × 13.1 ft)
Mass	4,000 kg (8,820 lb)
Launch date	July 15, 2009 STS-127 2J/A

JEM Remote Manipulator System	
Main Arm length	9.9 m (32.5 ft)
Small Fine Arm length	1.9 m (6.2 ft)

Nodes

Nodes are U.S. modules that connect the elements of the ISS. Node 1, called Unity, was the first U.S.-built element that was launched, and it connects the U.S. and Russian segments.

Node 2 and Node 3 are European-built elements and are each one rack bay longer than Node 1. Node 2 connects the U.S., European, and Japanese laboratories, as well as PMA-2. It offers two additional berthing ports. Node 3 is attached to the port side of Node 1 and provides accommodation for life-support equipment.



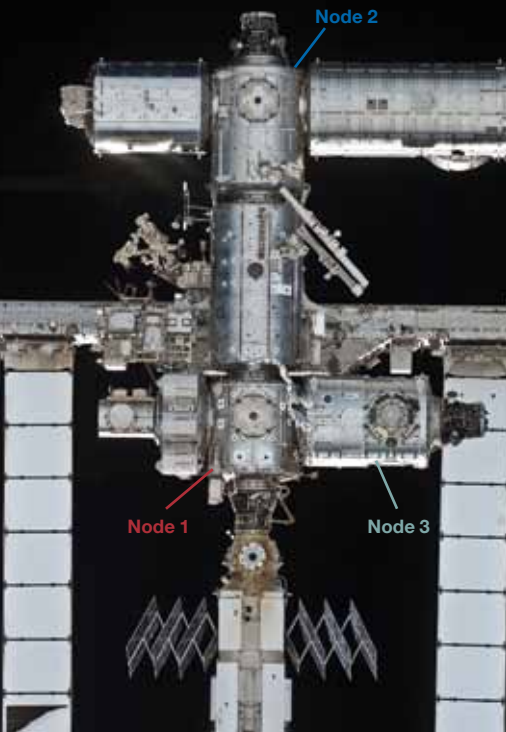
Mechanical assemblies—including berthing mechanisms and hatches, cable harnesses for electrical and data systems routing, and fluid lines for thermal control—add to the complexity of the node modules.



Mealtime in Node 1 with Expedition 23 and STS-131 crewmembers.



Astronaut Susan Helms floating in Node 1.



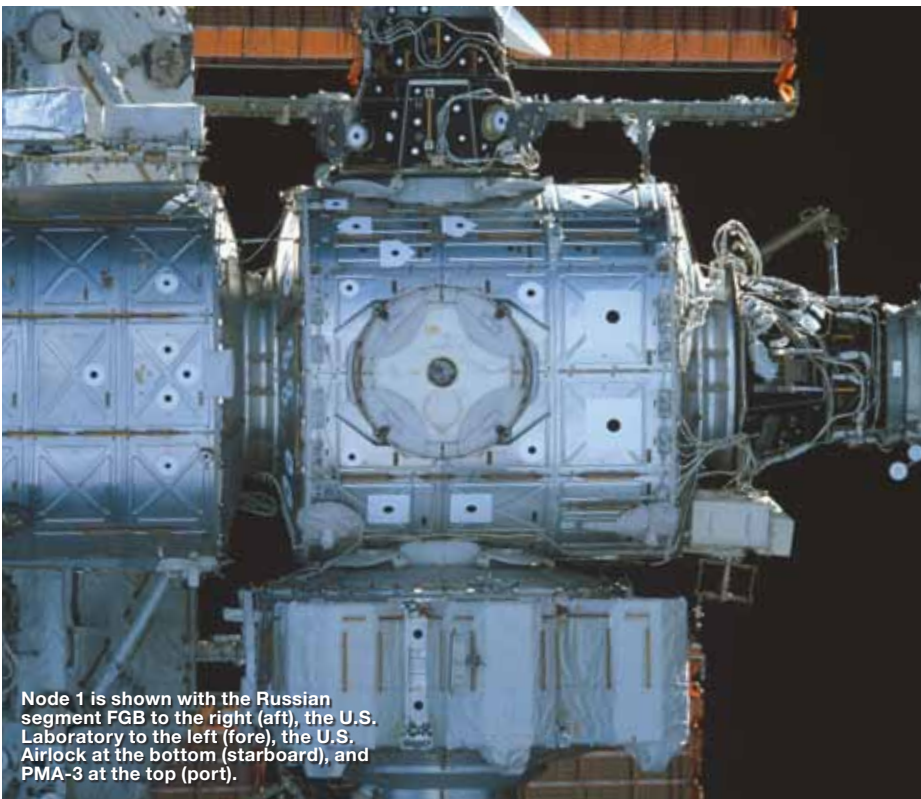
Node 1 Unity

NASA/Boeing

Node 1's six ports provide berthing connections to the Z1 Truss, U.S. Laboratory Module, Airlock, Node 3, and PMAs. The Multi-Purpose Logistics Module (MPLM) logistics carriers are berthed at Node 1 during some Shuttle visits.



Astronaut Jeffrey N. Williams (left), Expedition 13 NASA ISS science officer and flight engineer; European Space Agency (ESA) astronaut Thomas Reiter, flight engineer; and cosmonaut Pavel V. Vinogradov, commander representing Russia's Federal Space Agency, pose for a photo near the Unity node's growing collection of insignias representing crews who have lived and worked on the ISS.



Node 1 is shown with the Russian segment FGB to the right (aft), the U.S. Laboratory to the left (fore), the U.S. Airlock at the bottom (starboard), and PMA-3 at the top (port).



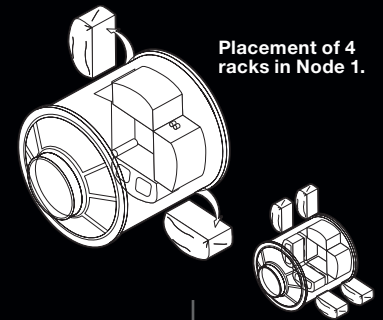
Expedition 23 crewmembers in Node 1.



Interior of Node 1 looking in to Node 3.



Astronaut Frank L. Culbertson, Jr., Expedition 3 mission commander, takes a break from his duties, as he plays with a miniature basketball and net in the Unity node on the ISS.

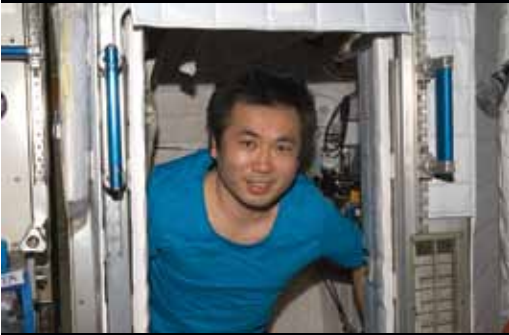


Placement of 4 racks in Node 1.

Length	5.5 m (18 ft)
Width (diameter)	4.3 m (14 ft)
Mass	11,895 kg (26,225 lb)
Exterior	Aluminum cylindrical sections, 2 endcones
Number of racks	4
Launch date	December 4, 1998 STS-88 2A



View of Node 2 as it was being closed out for launch.



Permanent crew quarters were added to Node 2, permitting expansion of the total ISS crew size to 6. Crew quarters are rack-sized containers built as small state-rooms for the off-duty crewmember. Each crew quarter contains lighting, Station Support Computer (SSC) laptop connectivity, power, fans, ventilation, and caution and warning.

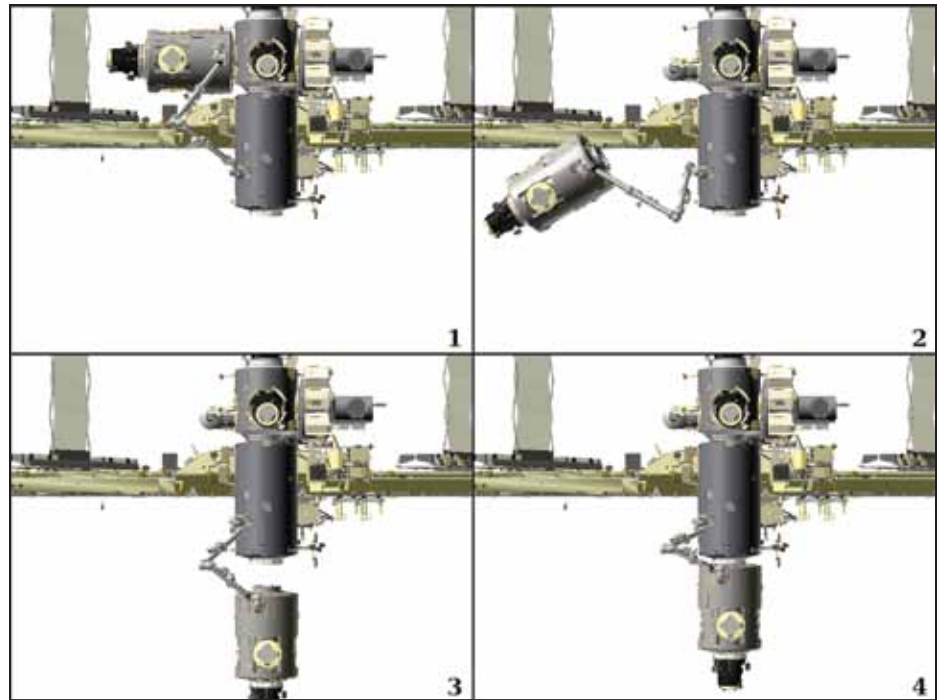


View looking into Node 2 from the PMA

Node 2 Harmony

ESA/Thales Alenia Space Italy (TAS-I)

Node 2 has been built in Europe by Thales Alenia Space Italy (TAS-I) under contract of the European Space Agency. It incorporates six docking ports: two in the longitudinal axis and four on two radial perpendicular axes. Node 2 is attached to the forward end of the U.S. laboratory and connects Columbus, the European laboratory, on the starboard side; Kibo, the Japanese laboratory, on the port side; the Pressurized Mating Adaptor 2 (PMA-2) on the forward side, which provides the primary docking location for the Space Shuttle; and the H-II Transfer Vehicle (HTV), a Japanese automatic carrier vehicle that will bring cargo to the ISS, on the nadir (Earth-facing) side. Note that the nadir port also serves as the MPLM docking port during Shuttle missions while the zenith port is a backup port. In addition, Node 2 provides the vital functional resources for the operation of the connected elements, namely the conversion and distribution of the electrical power, heating, cooling resources from the ISS Integrated Truss, and support of the data and video exchange with the ground and the rest of the ISS.



Initially Node 2 was berthed on the starboard port of Node 1. The ISS's remote manipulator moved Node 2 to the forward port of the U.S. Lab. PMA2 is berthed to the front port of Node 2.

Length	6.7 m (22 ft)
Width (diameter)	4.3 m (14 ft)
Mass	14,787 kg (32,599 lb)
Exterior	Aluminum cylindrical sections, 2 endcones
Number of racks	8
Launch date	October 23, 2007 STS-120 10A



Clay Anderson, Naoko Yamazaki, Rick Mastracchio, and Dorothy Metcalf-Lindenburger in Node 2 Harmony during STS-131/Expedition 23 Joint Docked OPS.



Node 2 after its installation during STS-120.

Node 3 Tranquility

ESA/Thales Alenia Space Italy (TAS-I)

Node 3 was built in Europe by Thales Alenia Space Italy (TAS-I) under contract of the European Space Agency. Node 3 is attached to the port side of Node 1, and the Cupola is berthed on its nadir (Earth facing) port. The PMA-3 is attached to the Node 3 port. The zenith port has been inhibited and modified to become the parking location of the ISS: Special Purpose Dexterous Manipulator (SPDM). The forward and aft ports are available for further ISS additions.

Node 3 accommodates ISS air revitalization, oxygen generation, and water recovery systems. It also accommodates the bathroom for the crew hygiene and exercising equipment such as a treadmill and type of weight-lifting device.



Node 3 hatch opening.



STS-130 commander George Zamka is photographed in Node 3 during Expedition 22/STS-130 joint operations.



In the grasp of the Canadarm2, the Pressurized Mating Adapter 3 (PMA-3) is relocated from the Harmony node to the open port on the end of the newly installed Tranquility node.



Crewmembers work to outfit Node 3 during Expedition 22/STS-130 joint operations.



Expedition 22 commander Jeffrey Williams and STS-130 mission specialist Kathryn Hire are photographed in Node 3 during Expedition 22/STS-130 joint operations.

Length	6.7 m (22 ft)
Width (diameter)	4.3 m (14 ft)
Mass	17,992 kg (39,665 lb)
Exterior	Aluminum cylindrical sections, 2 endcones
Number of racks	8
Launch dates	February 8, 2010 STS-130 20A

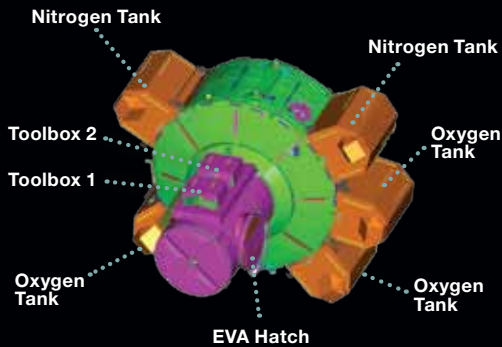
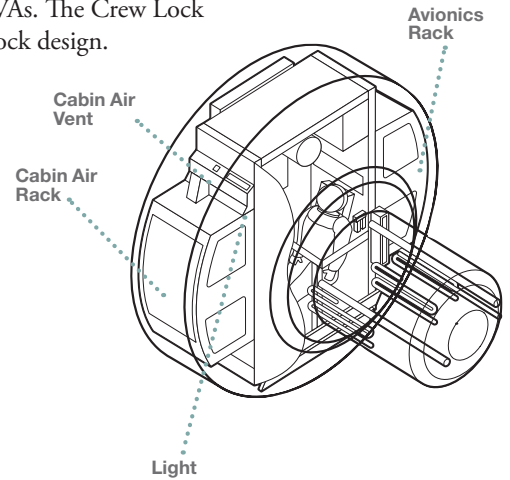
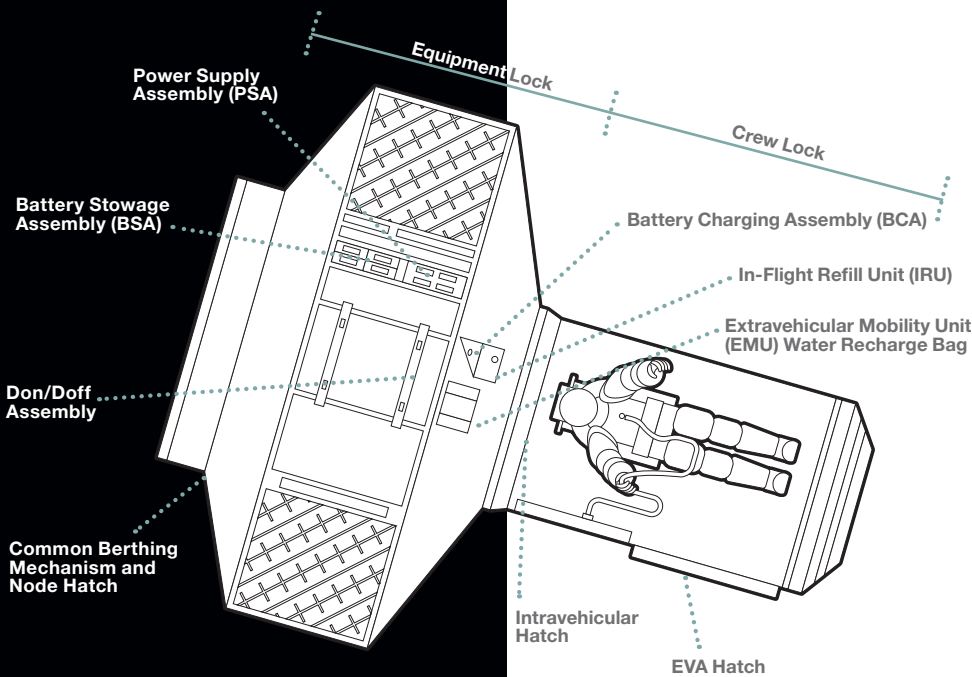
Joint Airlock Quest

NASA/Boeing

The Quest airlock provides the capability for extravehicular activity (EVA) using the U.S. Extravehicular Mobility Unit (EMU). The airlock consists of two compartments: the Equipment Lock, which provides the systems and volume for suit maintenance and refurbishment, and the Crew Lock, which provides the actual exit for performing EVAs. The Crew Lock design is based on the Space Shuttle's airlock design.



Crewmember exits the airlock extravehicular hatch.



Space Shuttle mission STS-104 berths Quest to the starboard side of Node 1 in July 2001.



Astronaut Tim Kopra, next to two EMU spacesuits, looks over a checklist in the Quest airlock.



Crewmember entering the airlock extravehicular hatch.

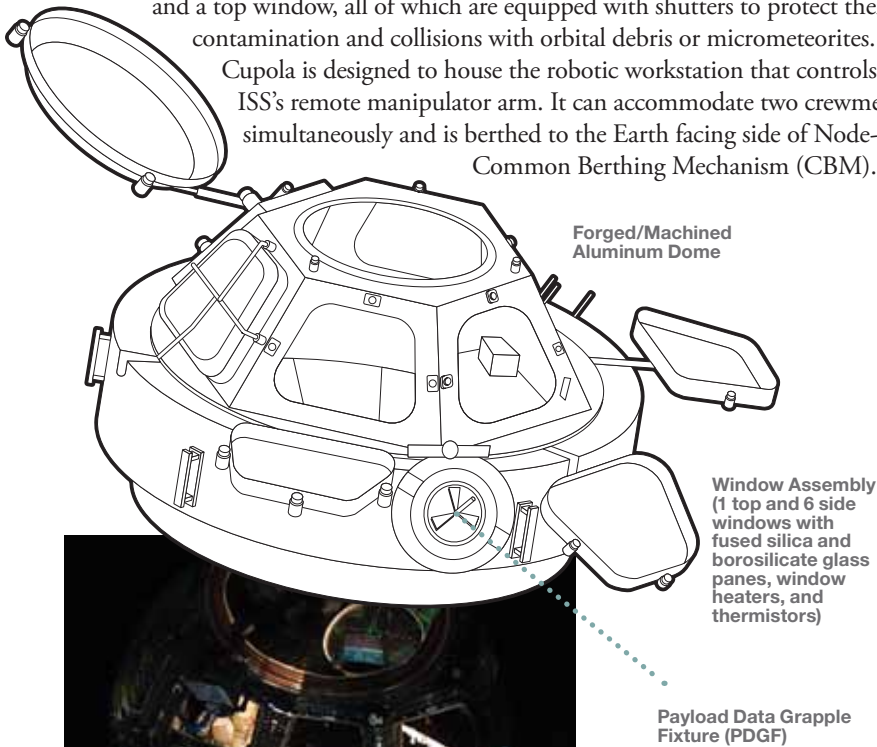
Length	5.5 m (18 ft)
Width	4.0 m (13.1 ft)
Mass	9,923 kg (21,877 lb)
Launch date	July 12, 2001 STS-104 7A

Cupola

ESA/Thales Alenia Italy (TAS-I)

The Cupola (named after the raised observation deck on a railroad caboose) is a small module designed for the observation of operations outside the ISS such as robotic activities, the approach of vehicles, and extravehicular activity (EVA). It was built in Europe by Thales Alenia Space Italy (TAS-I) under contract of the European Space Agency. It provides spectacular views of Earth and celestial objects. The Cupola has six side windows and a top window, all of which are equipped with shutters to protect them from contamination and collisions with orbital debris or micrometeorites. The

Cupola is designed to house the robotic workstation that controls the ISS's remote manipulator arm. It can accommodate two crewmembers simultaneously and is berthed to the Earth facing side of Node-3 using a Common Berthing Mechanism (CBM).



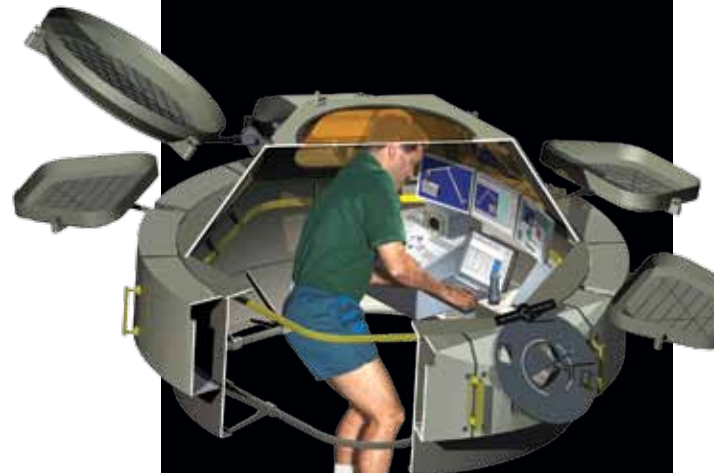
Command and control workstation based on portable computer system.



Crewmember TJ Creamer with a view of Earth through the Cupola's windows.



The Cupola in development.



Height	1.5 m (4.7 ft)
Diameter	3 m (9.8 ft)
Mass	1,880 kg (4,136 lb)
Capacity	2 crewmembers with portable workstation
Launch date	February 8, 2010 STS-130 20A



Crewmember George Zamka looking out through the Cupola's windows with shutters open.

Permanent Multipurpose Module (PMM)

NASA/ASI (Italian Space Agency) 

Derived from the Leonardo Multi-Purpose Logistics Module (MPLM), the Italian-built Permanent Multi-Purpose Module (PMM) is berthed to the nadir port of Node 1. It can host up to 16 racks containing equipment, experiments, and supplies, and it has an additional storage space for bags in the aft endcone.

Mounted in the Shuttle's cargo bay for launch, the module will be transferred to the ISS using the ISS's robotic arm after the Shuttle has docked.

It will be then activated and integrated to the ISS, providing an additional stowage place and a location to perform science and other activities.



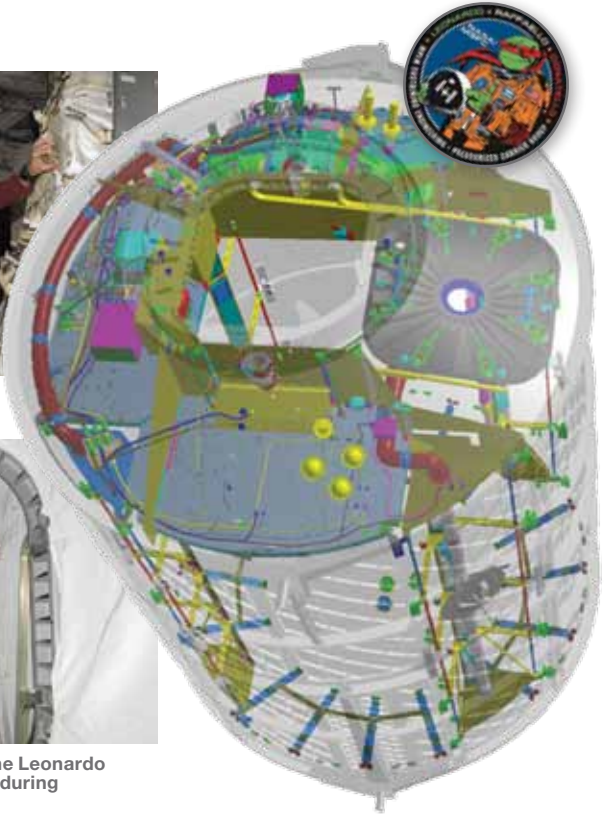
The station's robotic Canadarm2 grapples the Leonardo Multi-Purpose Logistics Module (MPLM) from the payload bay of the docked Space Shuttle *Discovery* (STS-131) for relocation to a port on the Harmony node of the ISS. Earth's horizon and the blackness of space provide the backdrop for the scene. Canadian-built Dexter, also known as the Special Purpose Dexterous Manipulator (SPDM), is visible at bottom center.



Astronaut Nicole Stott in Leonardo.

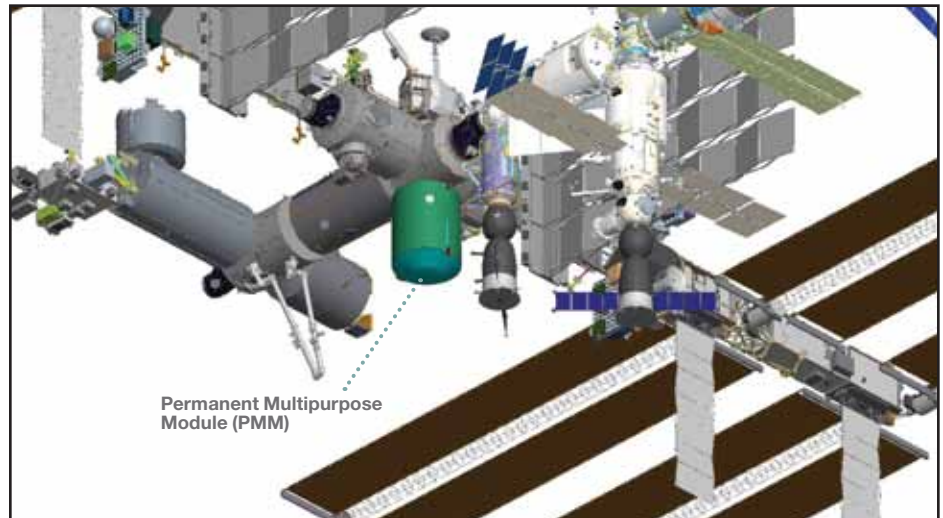


Sandra Magnus works with stowage in the Leonardo Multi-Purpose Logistics Module (MPLM) during Expedition 18/STS-126 joint operations.



MPLM Raffaello berthed on Node 1.

Length	6.67 m (21.7 ft)
Diameter Exterior Interior	4.5 m (14.76 ft) 4.21 m (13.81 ft)
Mass	4,428 kg (9,784 lb)
Pressurized volume	76.7 m ³ (2708.6 ft ³)
Cargo capability	9,000 kg (20,000 lb)
Pressurized habitable volume	31 m ³ (1,095 ft ³)



Functional Cargo Block (FGB) Zarya (Sunrise)

NASA/Boeing/Khrunichev State Research and Production Space Center

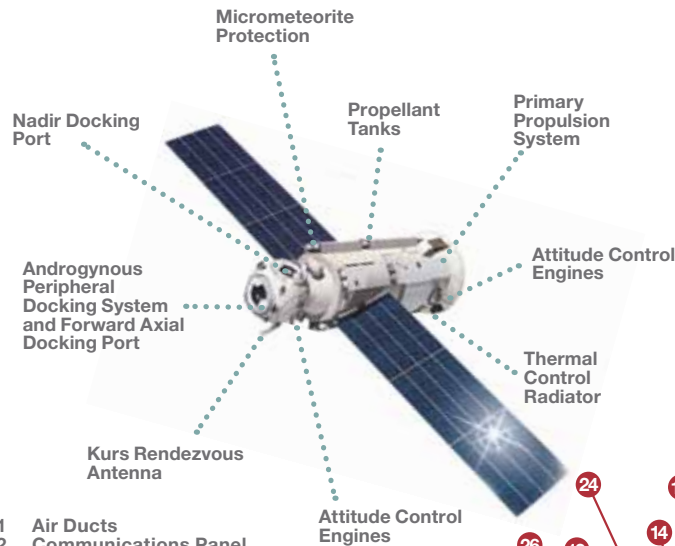
The FGB was the first launched element of the ISS, built in Russia under a U.S. contract. During the early stages of ISS assembly, the FGB was self-contained, providing power, communications, and attitude control functions. Now, the FGB module is used primarily for storage and propulsion. The FGB was based on the modules of Mir.



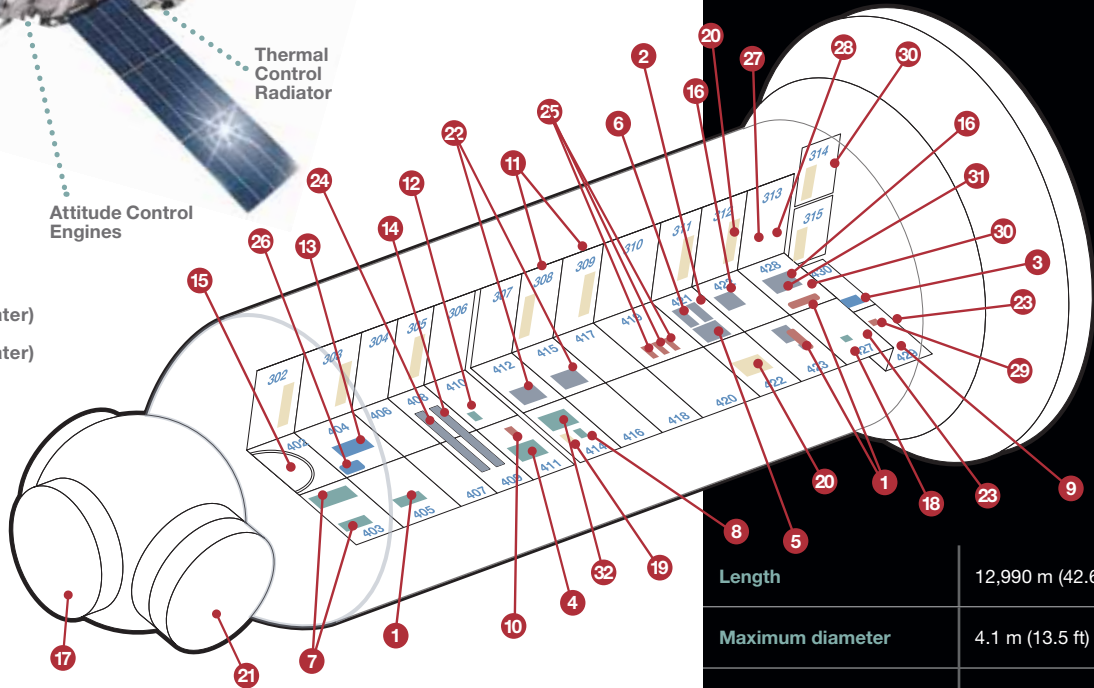
View of the FGB on orbit flanked by the Service Module and PMA-1.



Russian cosmonaut Oleg Kotov moves a stowage bag in the Zarya Functional Cargo Block (FGB).



- 1 Air Ducts
- 2 Communications Panel
- 3 Caution and Warning Systems Panel
- 4 Contaminant Filters
- 5 Contingency Transfer (Water) Container Bag
- 6 Contingency Transfer (Water) Container Connections
- 7 Dust Collectors
- 8 Electrical Outlet
- 9 Flex Airduct Container
- 10 Fuse
- 11 Fuse Panels (behind close-outs)
- 12 Gas Analyzer
- 13 Gas Mask
- 14 Handrail
- 15 Hatch Protection
- 16 Instrument Containers
- 17 Docking Port to PMA
- 18 Laptop Outlets
- 19 Lighting Panel
- 20 Lights
- 21 Nadir Docking Port
- 22 Onboard Documentation
- 23 Onboard Network Receptacle Outlets
- 24 Pole and Hook
- 25 Portable Fans
- 26 Removable Fire Extinguisher
- 27 Power Outlet
- 28 Pressurized Valve Unit
- 29 Caution and Warning Panel
- 30 Smoke Detector
- 31 TV Outlet
- 32 Wipes/Filters



Russian cosmonaut Maxim Suraev using the communications system in the FGB.

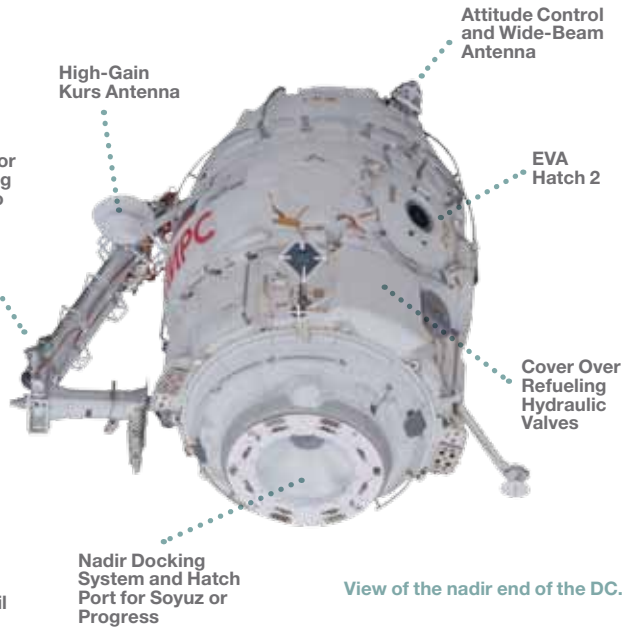
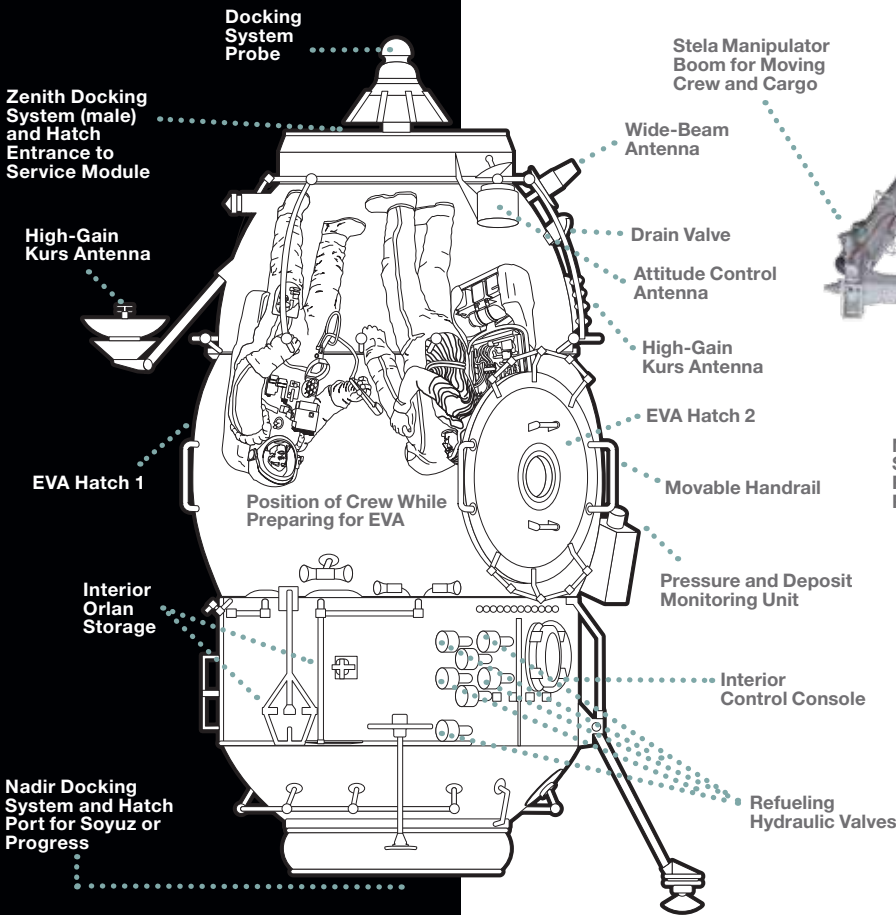
Length	12,990 m (42.6 ft)
Maximum diameter	4.1 m (13.5 ft)
Mass	24,968 kg (55,045 lb)
Pressurized volume	71.5 m ³ (2,525 ft ³)
Solar array span	24.4 m (80 ft)
Array surface area	28 m ² (301 ft ²)
Power supply (avg.)	3 kW
Propellant mass	3,800 kg (8,377 lb)
Launch date	November 20, 1998 Proton rocket 1A/R

Docking Compartment (DC) Pirs (Pier)

Russian Federal Space Agency (Roscosmos)/S.P. Korolev Rocket and Space Corporation Energia (RSC Energia)

Pirs serves as a docking port for the Russian Segment. Pirs also provides the capability for extravehicular activity (EVA) using Russian Orlan spacesuits. Additionally, Pirs provides systems for servicing and refurbishing the Orlan spacesuits. The nadir Docking System on Pirs provides a port for the docking of Soyuz and Progress vehicles. When the final Russian science module arrives, Pirs will be deorbited.

View of the zenith end of the DC, with probe extended, as it prepares to dock with the ISS in 2001.



View of the nadir end of the DC.



DC in preparation for launch.



Cosmonaut Maxim Suraev poses with two Orlan spacesuits inside Pirs.



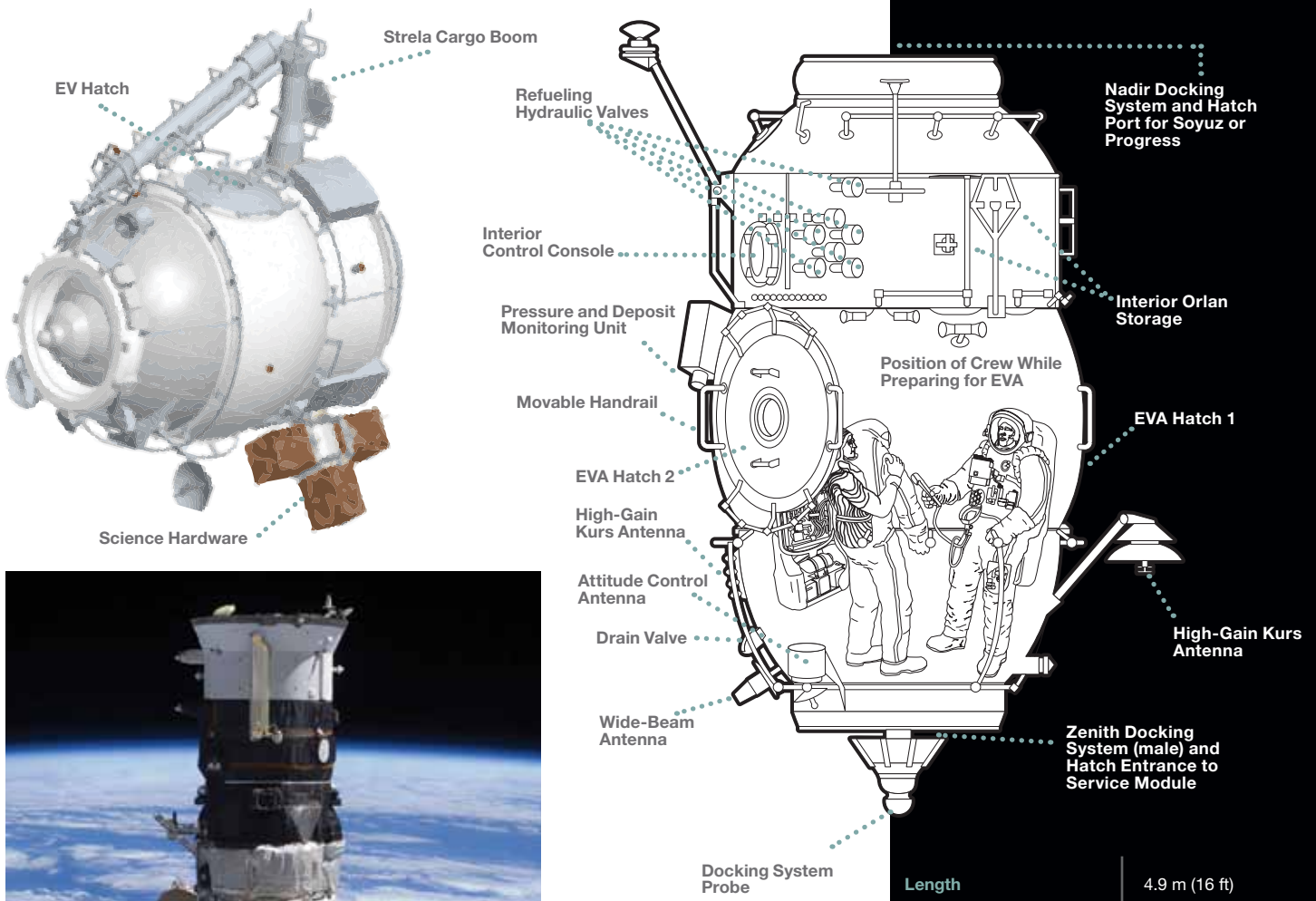
Pirs Module location at Service Module nadir.

Length	4.9 m (16 ft)
Maximum diameter	2.55 m (8.4 ft)
Mass	3,838 kg (8,461 lb)
Volume	13 m ³ (459 ft ³)
Launch date	September 15, 2001 Progress M 4R

Mini-Research Module 2 (MRM2) Poisk (Explore)

Russian Federal Space Agency (Roscosmos)/S.P. Korolev Rocket and Space Corporation Energia (RSC Energia)

Poisk, also known as the MRM2, is almost identical to the Pirs Docking Compartment. Poisk provides the capability for extravehicular activity (EVA) using Russian Orlan spacesuits. Additionally, Poisk provides systems for servicing and refurbishing the Orlan spacesuits. The zenith docking system on Poisk provides a port for the docking of Soyuz and Progress vehicles. Poisk will also provide extra space for scientific experiments, including power supply outlets and data transmission interfaces for five external workstations. The module is also equipped with three temporary internal workstations near the module's side windows to observe a local horizon plane and to accommodate payloads equipped with vacuum interfaces.



Length	4.9 m (16 ft)
Maximum diameter	2.55 m (8.4 ft)
Mass	3,795 kg (8,367 lb)
Volume	14.8 m ³ (523 ft ³)
Launch date	November 10, 2009 Progress M 5R



View of Rassvet Mini-Research Module 1 (MRM1) taken during Expedition 23 / STS-132 Joint Operations.



MRM1 Flight Article is manufactured from the pressurized compartment of the Science Power Platform (SPP) Dynamic Test Article.

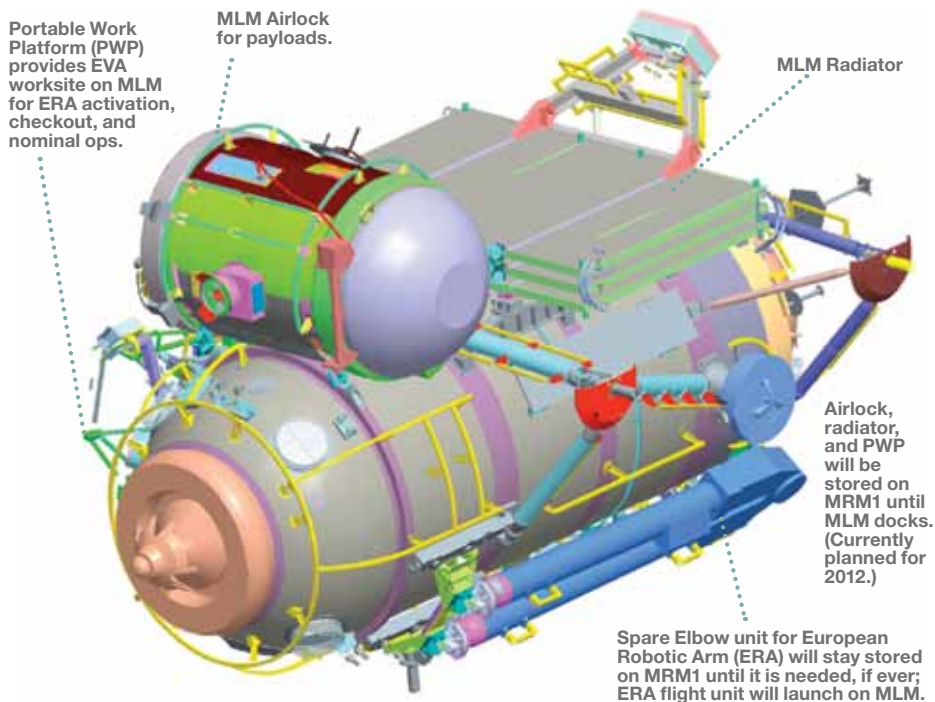


MRM1 Flight Article being assembled.

Mini-Research Module 1 (MRM1) Rassvet (Dawn)

Russian Federal Space Agency (Roscosmos)/S.P. Korolev Rocket and Space Corporation Energia (RSC Energia)

Rassvet, also known as the MRM1, is used for docking and cargo storage. It is also equipped with eight internal workstations so it can serve as a mini research laboratory. The nadir docking system on Rassvet provides the fourth docking port on the Russian segment for the docking of Soyuz and Progress vehicles. It was built from the pressurized hull of the Science Power Platform (SPP) dynamic test article. Moreover, the exterior of Rassvet carries a spare elbow joint for the European Robotic Arm (ERA) and outfitting equipment for the Russian Multi-Purpose Laboratory Module (MLM), including a radiator, an airlock for payloads, and a Portable Work Platform (PWP) that provide an external worksite for ERA activation, checkout, and nominal operations.



Length	6.0 m (19.7 ft)
Maximum diameter	2.35 m (7.7 ft)
Mass	5,075 kg (11,188 lb)
Volume	17.4 m ³ (614 ft ³)
Launch date	May 2010 STS-132 ULF4
Attitude control	32 engines
Orbital maneuvering	2 engines



Service Module (SM) Zvezda (Star)

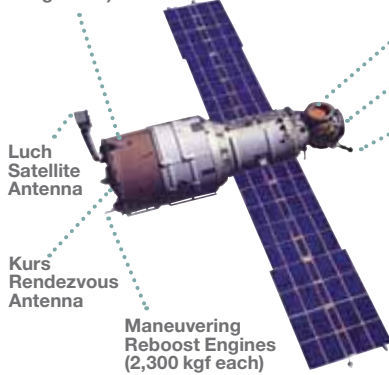
Russian Federal Space Agency (Roscosmos)/S.P. Korolev Rocket and Space Corporation Energia (RSC Energia)

The Service Module was the first fully Russian contribution, providing early living quarters, life-support system, electrical power distribution, data processing system, flight control system, and propulsion system. Its communications system still enables remote command capabilities from ground flight controllers. Although some of these systems were subsequently supplemented by U.S. systems, the Service Module remains the structural and functional center of the Russian segment of the ISS. The Service Module was intended primarily to support crew habitation but became the first multipurpose research laboratory on the ISS.

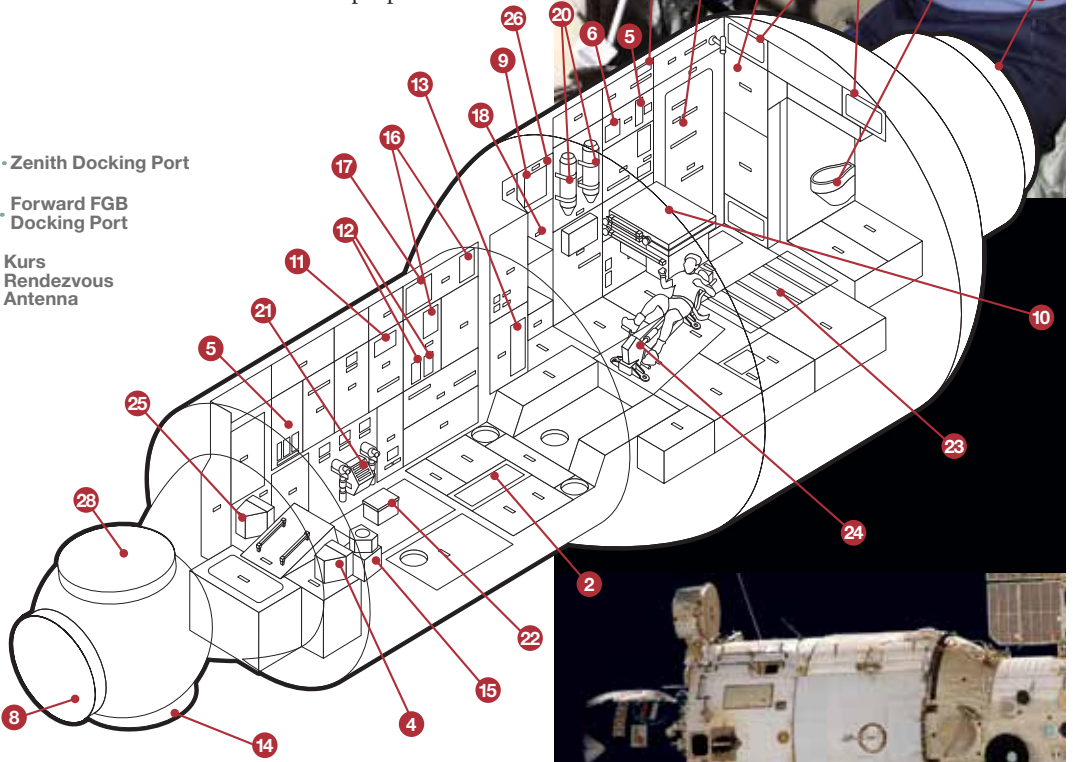
Cosmonaut Yury V. Usachev in his crew compartment.



Attitude Control Engines
 (6 clusters, 32 engines, 14 kgf each)

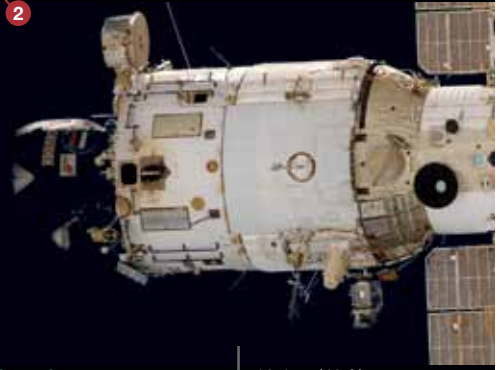


Zenith Docking Port
 Forward FGB Docking Port
 Kurs Rendezvous Antenna



- 1 Airflow Vent
- 2 Body Mass Measurement Device
- 3 Camera
- 4 Caution and Warning Panel, Clock, and Monitors
- 5 Communications Panel
- 6 Condensate Water Processor
- 7 Crew Sleep Compartment
- 8 Forward Docking Port (to FGB)
- 9 Fuses
- 10 Galley Table
- 11 Integrated Control Panel
- 12 Lighting Control Panels
- 13 Maintenance Box
- 14 Nadir Docking Port
- 15 Navigation Sighting Station
- 16 Night-Lights
- 17 Power Distribution Panel
- 18 Recessed Cavity & Valve Panel
- 19 Smoke Detector

- 20 Solid Fuel Oxygen Generators (SFOG)
- 21 Toru Rendezvous Control Station
- 22 Toru Seat
- 23 Treadmill & Vibration Isolation System
- 24 Vela Ergometer
- 25 Ventilation Screen
- 26 Vozdukh Control Panel
- 27 Waste Management Compartment
- 28 Zenith Docking Port
- 29 Soyuz and Progress Docking Port



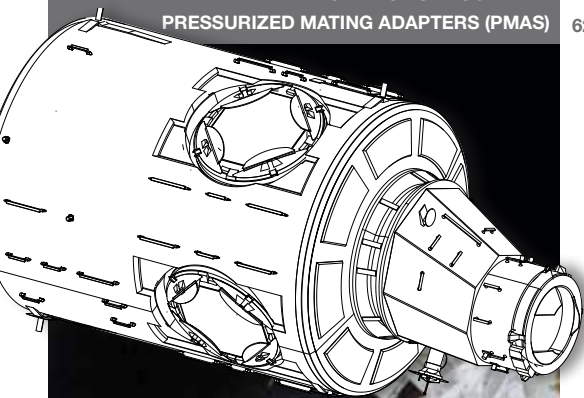
Length	13.1 m (43 ft)
Diameter	4.2 m (13.5 ft)
Wingspan	29.7 m (97.5 ft)
Weight	24,604 kg (54,242 lb)
Launch date	July 12, 2000 Proton 1R
Attitude control	32 engines
Orbital maneuvering	2 engines



The SM's hull under construction at Khronichev State Research and Production Space Center in Moscow.



Leroy Chiao exercises in the SM.

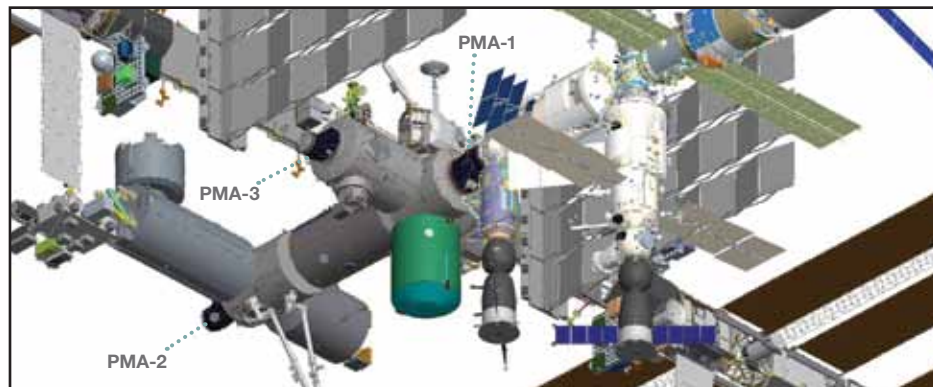


Pressurized Mating Adapters (PMAs)

NASA/Boeing

Three conical docking adapters, called Pressurized Mating Adapters, attach to the Nodes' berthing mechanisms. The other sides of the adapters allow for docking with Russian modules and the Space Shuttle. PMA-1 links the U.S. and Russian segments, while PMA-2 and PMA-3 serve as the primary and backup docking ports for the Space Shuttle.

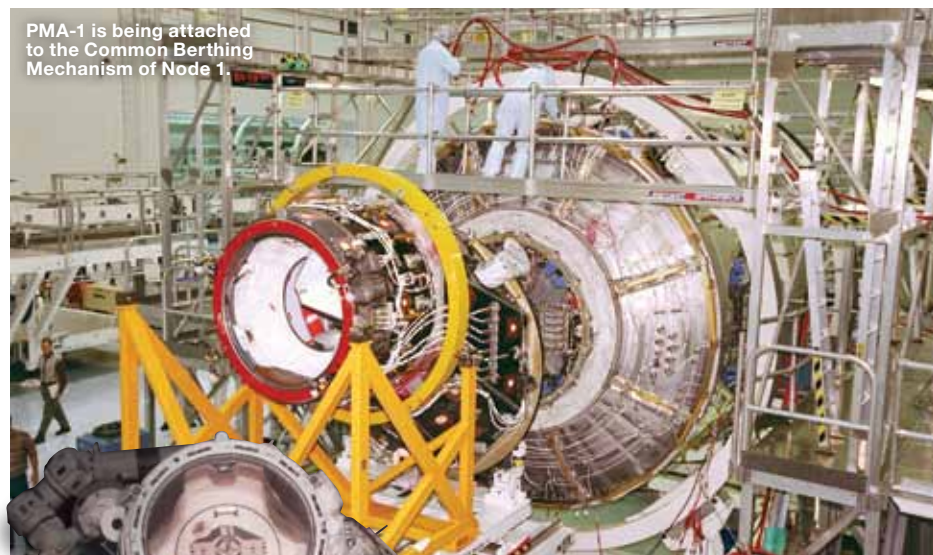
The PMA-1, 2, and 3 structures are identical and provide a pressurized interface between the U.S. and Russian ISS modules and between the U.S. modules and the Space Shuttle orbiter. The PMA structure is a truncated conical shell with a 28-inch axial offset in the diameters between the end rings.



Astronaut Michael Lopez-Alegria participates in a spacewalk during STS-113. The Space Shuttle Endeavour is docked to the Pressurized Mating Adapter 2 (PMA-2).

Length	1.86 m (6.1 ft)
Width	1.9 m (6.25 ft) at wide end, 1.37 m (4.5 ft) at narrow end
Mass of	
PMA-1	1,589 kg (3,504 lb)
PMA-2	1,376 kg (3,033 lb)
PMA-3	1,183 kg (2,607 lb)
Launch date	
PMA-1 and 2	December 4, 1998 STS-88 ISS-2A
PMA-3	October 11, 2000 STS-92 ISS-3A

PMA-1 is being attached to the Common Berthing Mechanism of Node 1.



PMA-2 on the forward berthing ring of Node 1.



PMA structure shows a series of offset aluminum cylinders.

how it's supported

The ISS program's greatest accomplishment is as much a human achievement as a technological one. The global partnership of space agencies exemplifies meshing of cultural differences and political intricacies to plan, coordinate, provide, and operate the complex elements of the ISS. The program also brings together international flight crews and globally distributed launch, operations, training, engineering, communications networks, and scientific research communities.

Maintaining the ISS is a arduous task, requiring an international fleet of vehicles and launch locations to rotate crewmembers; replenish propellant; provide science experiments, necessary supplies, and maintenance hardware; and remove and dispose of waste. All of these important deliveries sustain a constant supply line crucial to the operations of the ISS.

ISS Operations and Management



CSA Headquarters
ISS Program Management
MSS Operation Complex
CSA Payload Telescience Science Operations Center (PTOC)
Saint-Hubert, Quebec, Canada

Glenn Research Center
Telescience Support Center
Cleveland, Ohio, U.S.

Ames Research Center
Telescience Support Center
Moffett Field, California, U.S.

Johnson Space Center
ISS Program Management
ISS Mission Control Center (MCC)
ISS Training
Houston, Texas, U.S.

NASA Headquarters
Washington, DC, U.S.

Marshall Space Flight Center
Payload Operations and Integration Center (POIC)
Huntsville, Alabama, U.S.

Kennedy Space Center
Shuttle Launch Control
Cape Canaveral, Florida, U.S.

Ariane Launch Control
Kourou, French Guiana





ESA European Space Research and Technology Centre (ESTEC)
ISS Program Management
Noordwijk, Netherlands

ESA Headquarters
Paris, France

TsUP (Moscow Mission Control Center)
Korolev, Russia

Gagarin Cosmonaut Training Center (GCTC)
Star City, Russia

Roscosmos Headquarters
ISS Program Management
Moscow, Russia

JAXA Tsukuba Space Center
ISS Program Management
JEM Mission Control (JEMMC)
HTV Control Center (HTVCC)
Astronaut Training Facility (ATF)
Tsukuba, Japan

European Astronaut Centre
Microgravity User Support Centre (MUSC)
Cologne, Germany

Russian Launch Control
Baikonur Cosmodrome,
Baikonur, Kazakhstan

Columbus Control Center (COL-CC)
Oberpfaffenhofen, Germany

Tanegashima Space Center
H-II Launch Control
Tanegashima, Japan

JAXA Headquarters
Tokyo, Japan

ATV Control Center (ATV-CC)
Centre d'Aide au Développement des activités en Micro-pesanteur et des Opérations Spatiales (CADMOS)
Toulouse, France



Canada

Canadian Space Agency (CSA)



Mobile Servicing System (MSS) Operations Complex (MOC)

Located in Saint Hubert, Quebec, the MSS Operations Complex is composed of the following facilities:

- Space Operations Support Centre (SOSC)
- MSS Operations and Training System (MOTS)
- Virtual Operations Training Environment (VOTE)
- Canadian MSS Training Facility (CMTF)

These facilities provide the resources, equipment and expertise for the engineering and monitoring of the MSS and provide crew training on Canadian systems.

Payload Telescience Operations Centre (PTOC)

The PTOC in Saint Hubert supports real time operations for Canadian Payloads onboard the ISS.

Space Station Remote Manipulator System (SSRMS) Design and Development

The SSRMS was designed and built for the CSA by MDA of Brampton, Ontario.

<http://www.asc-csa.gc.ca>



Europe

European Space Agency (ESA)



European Space Research and Technology Centre (ESTEC)

The European Space Research and Technology Centre in Noordwijk, the Netherlands, is the largest ESA establishment, a test center and hub for European space activities. It has responsibility for the technical preparation and management of ESA space projects and provides technical support to ESA's ongoing satellite, space exploration, and human space activities.

Columbus Control Centre (COL-CC) and Automated Transfer Vehicle CONTROL Centre (ATV-CC)

Two ground control centers are responsible for controlling and operating the European contribution to the ISS program. These are the Columbus Control Centre and the Automated Transfer Vehicle Control Centre. The COL-CC, located at the German Aerospace Center (DLR), in Oberpfaffenhofen, near Munich, Germany, controls and operates the Columbus laboratory and coordinates the operation of European experiments. The ATV-CC, located in Toulouse, France, on the premises of the French Space Agency, CNES, operates the European ATV during the active and docked mission phases of the ATV.

Guiana Space Centre (GSC)

Europe's Spaceport is situated in the northeast of South America in French Guiana. Initially created by CNES, it is jointly funded and used by both the French space agency and ESA as the launch site for the Ariane 5 vehicle.

European Astronaut Centre (EAC)

The European Astronaut Centre of the European Space Agency is situated in Cologne, Germany. It was established in 1990 and is the home base of the 13 European astronauts who are members of the European Astronaut Corps.

User Centers

User Support and Operation Centers (USOCs) are based in national centers distributed throughout Europe. These centers are responsible for the use and implementation of European payloads aboard the ISS.

<http://www.esa.int>



Japan

Japan Aerospace Exploration Agency (JAXA)



In addition to the JAXA headquarters in Tokyo and other field centers throughout the country, Tsukuba Space Center and Tanegashima Launch Facility are JAXA's primary ISS facilities.

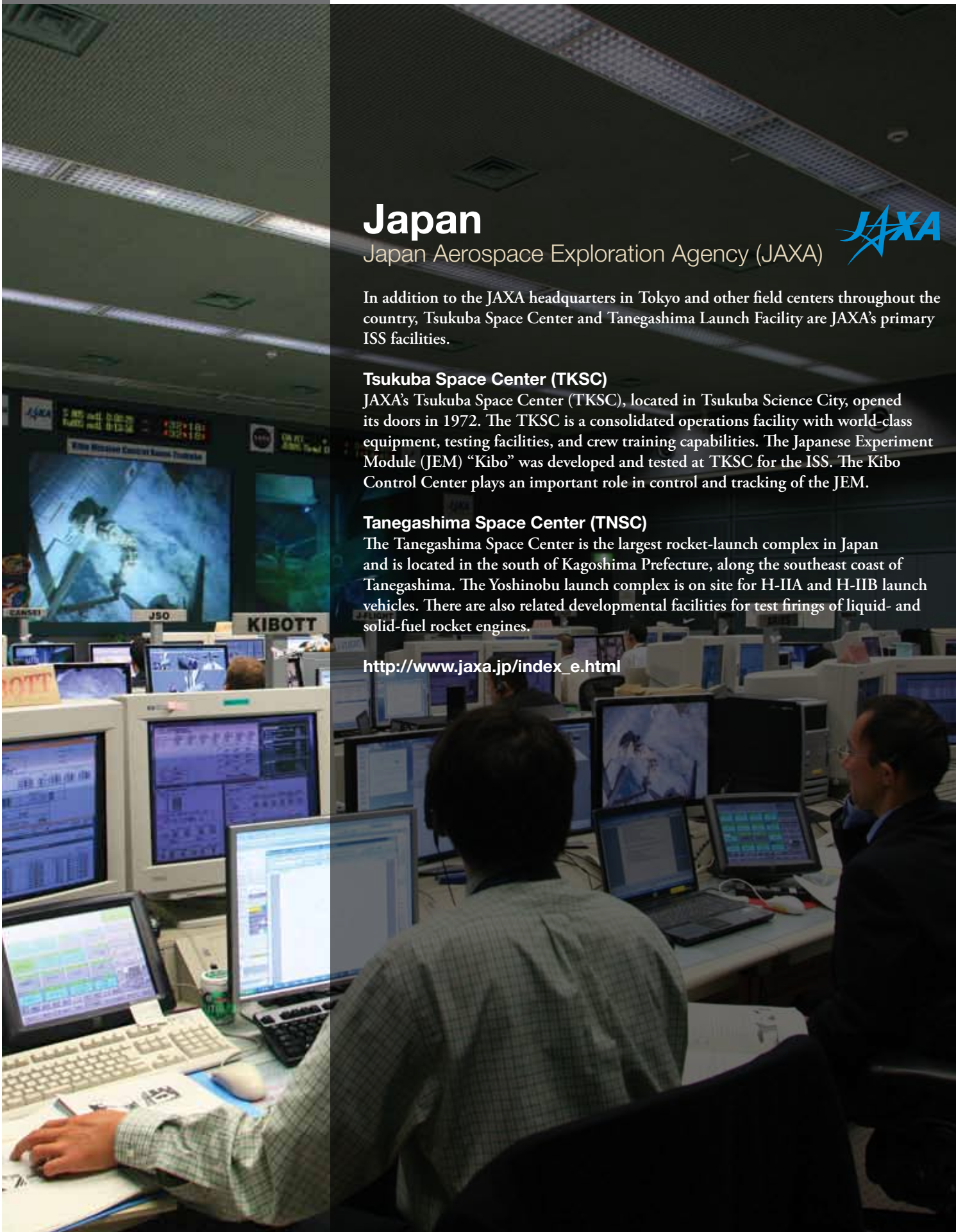
Tsukuba Space Center (TKSC)

JAXA's Tsukuba Space Center (TKSC), located in Tsukuba Science City, opened its doors in 1972. The TKSC is a consolidated operations facility with world-class equipment, testing facilities, and crew training capabilities. The Japanese Experiment Module (JEM) "Kibo" was developed and tested at TKSC for the ISS. The Kibo Control Center plays an important role in control and tracking of the JEM.

Tanegashima Space Center (TNSC)

The Tanegashima Space Center is the largest rocket-launch complex in Japan and is located in the south of Kagoshima Prefecture, along the southeast coast of Tanegashima. The Yoshinobu launch complex is on site for H-IIA and H-IIB launch vehicles. There are also related developmental facilities for test firings of liquid- and solid-fuel rocket engines.

http://www.jaxa.jp/index_e.html



Russia

Roscosmos, Russian Federal Space Agency



Roscosmos oversees all Russian human space flight activities.

Moscow Mission Control Center (TsUP)

Moscow Mission Control Center is the primary Russian facility for the control of Russian human spaceflight activities and operates the ISS Russian segment. It is located in Korolev, outside of Moscow, at the Central Institute of Machine building (TsNIIMASH) of Roscosmos.

Gagarin Research and Test Cosmonaut Training Center (GCTC)

The Gagarin cosmonaut training center, at Zvezdny Gorodok (Star City), near Moscow, provides full-size trainers and simulators of all Russian ISS modules, a water pool used for spacewalk training, centrifuges to simulate g-forces during liftoff, and a planetarium used for celestial navigation.

Baikonur Cosmodrome

The Baikonur Cosmodrome, in Kazakhstan, is the chief launch center for both piloted and unpiloted space vehicles. It supports the Soyuz and Proton launch vehicles and plays an essential role in the deployment and operation of the ISS.

<http://www.roscosmos.ru>





United States of America

National Aeronautics and Space Administration
(NASA)



NASA Headquarters (HQ)

NASA Headquarters in Washington, DC, exercises management over the NASA Field Centers, establishes management policies, and analyzes all phases of the ISS program.

Johnson Space Center (JSC)

Johnson Space Center in Houston, TX, directs the ISS program. Mission control operates the U.S. On-orbit Segment (USOS) and manages activities across the ISS in close coordination with the international partner control centers. JSC is the primary center for spacecraft design, development, and mission integration. JSC is also the primary location for crew training.

Kennedy Space Center (KSC)

Kennedy Space Center in Cape Canaveral, FL, prepares the ISS modules and Space Shuttle orbiters for each mission, coordinates each countdown, and manages Space Shuttle launch and post-landing operations.

Marshall Space Flight Center (MSFC)

Marshall Space Flight Center's Payload Operations and Integration Center (POIC) controls the operation of U.S. experiments and coordinates partner experiments aboard the ISS. MSFC oversaw development of most U.S. modules and the ISS ECLSS system.

Telescience Support Centers (TSCs)

Telescience Support Centers around the country are equipped to conduct science operations on board the ISS. These TSCs are located at Marshall Space Flight Center in Huntsville, AL; Ames Research Center (ARC) in Moffett Field, CA; Glenn Research Center (GRC) in Cleveland, OH; and Johnson Space Center in Houston, TX.

<http://www.nasa.gov>





Soyuz

Roscosmos
Russia



Proton



H-IIB

JAXA
Japan



Ariane

ESA
Europe



Shuttle

NASA
United States

	Russia		Japan	Europe	U.S.
	Soyuz SL-4	Proton SL-12	H-IIB	Ariane 5	Space Shuttle
First launch to ISS	2000	1998	2009	2008	1998
Launch site(s)	Baikonur Cosmodrome	Baikonur Cosmodrome	Tanegashima Space Center	Guiana Space Center	Kennedy Space Center
Launch performance payload capacity	7,150 kg (15,750 lb)	20,000 kg (44,000 lb)	16,500 kg (36,400 lb)	18,000 kg (39,700 lb)	18,600 kg (41,000 lb) 105,000 kg (230,000 lb), orbiter only
Return performance payload capacity	N/A	N/A	N/A	N/A	18,600 kg (41,000 lb) 105,000 kg (230,000 lb), orbiter only
Number of stages	2 + 4 strap-ons	4 + 6 strap-ons	2 + 4 strap-ons	2 + 2 strap-ons	1.5 + 2 strap-ons
Length	49.5 m (162 ft)	57 m (187 ft)	57 m (187 ft)	51 m (167 ft)	56.14 m (18.2 ft) 37.24 m (122.17 ft), orbiter only
Mass	310,000 kg (683,400 lb)	690,000 kg (1,521,200 lb)	531,000 kg (1,170,700 lb)	746,000 kg (1,644,600 lb)	2,040,000 kg (4,497,400 lb)
Launch thrust	6,000 kN (1,348,800 lbf)	9,000 kN (2,023,200 lbf)	5,600 kN (1,258,900 lbf)	11,400 kN (2,562,820 lbf)	34,677 kN (7,795,700 lbf)
Payload examples	Soyuz Progress Pirs	Service Module Functional Cargo Block (FGB) Multipurpose Lab Module (MLM)	H-II Transfer Vehicle (HTV)	Ariane Automated Transfer Vehicle (ATV)	Shuttle Orbiter, Nodes 1-3, U.S. Lab, JEM, Truss elements, Airlock, SSRMS



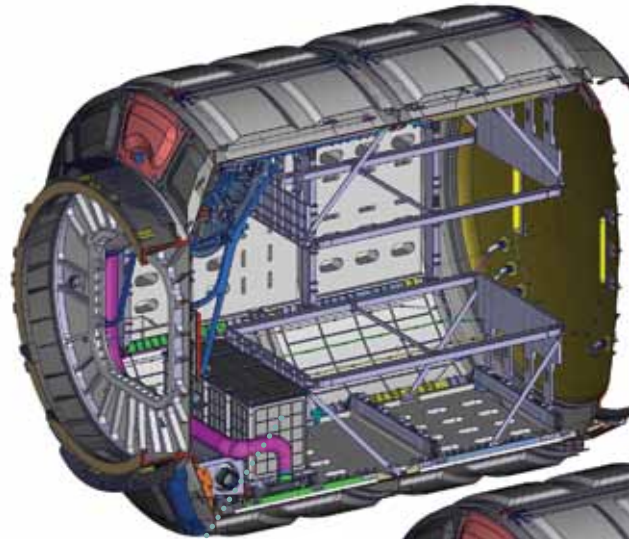
Cygnus spacecraft.

Taurus II launch vehicle.

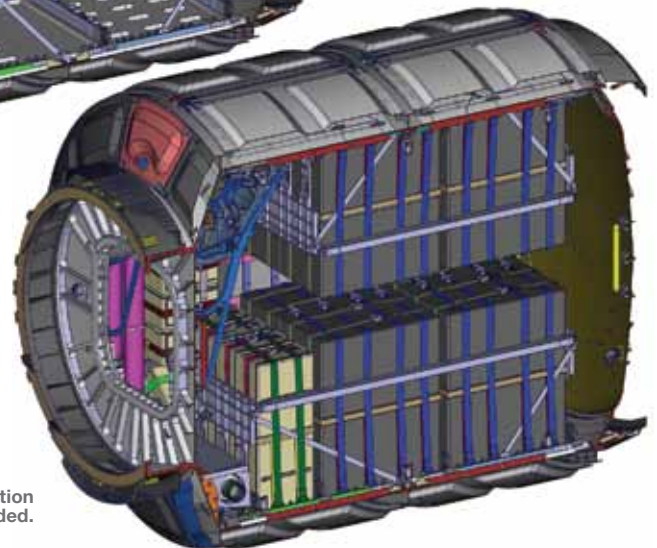
Taurus II and Cygnus

Orbital Sciences Corporation

The Cygnus spacecraft is an automated logistical resupply vehicle design to rendezvous with the ISS and then be grappled and berthed using the Space Station Remote Manipulator System (SSRMS). The Cygnus offers the capability to carry ISS pressurized cargo (logistics and utilization) within the Pressurized Cargo Module (PCM). The Cygnus is launched aboard a new launch vehicle known as the Taurus II from the NASA Wallops Flight Facility in Wallops Island, VA. The Cygnus can bring dry cargo, gas, water, and payloads. After the cargo is transferred to the ISS, the Cygnus can be loaded with trash and waste products. After departing the ISS, the Cygnus will be destroyed (incinerated) upon reentry into Earth's atmosphere.



PCM—Active Configuration with no cargo bags loaded.



Middeck Lockers (active and passive)

PCM—Passive Configuration with cargo bags fully loaded.

Taurus II	
Height	40.1 m (131.56 ft)
Diameter	3.9 m (12.80 ft)
Mass at launch	275,000 kg (606,271 lb)
First stage thrust	3.45 MN (775,000 lb)
Second stage thrust	320 kN (72,000 lb)
Cygnus	
Height	5.1 m (16.73 ft)
Diameter	3.05 m (10 ft)
Maximum Pressurized Cargo	Up mass/volume
	2,000 kg (4,409 lb) 18.75 m ³ (662 ft ³)
Down mass/volume	2,000 kg (4,409 lb) 18.75 m ³ Disposed (662 ft ³)
	0
Maximum Unpressurized Cargo	Up mass/volume
	0
Payload volume	Pressurized
	7.6 m ³ (25 ft ³)



Taurus II Castor 30 2nd Stage Motor.



Cygnus pressurized cargo module.

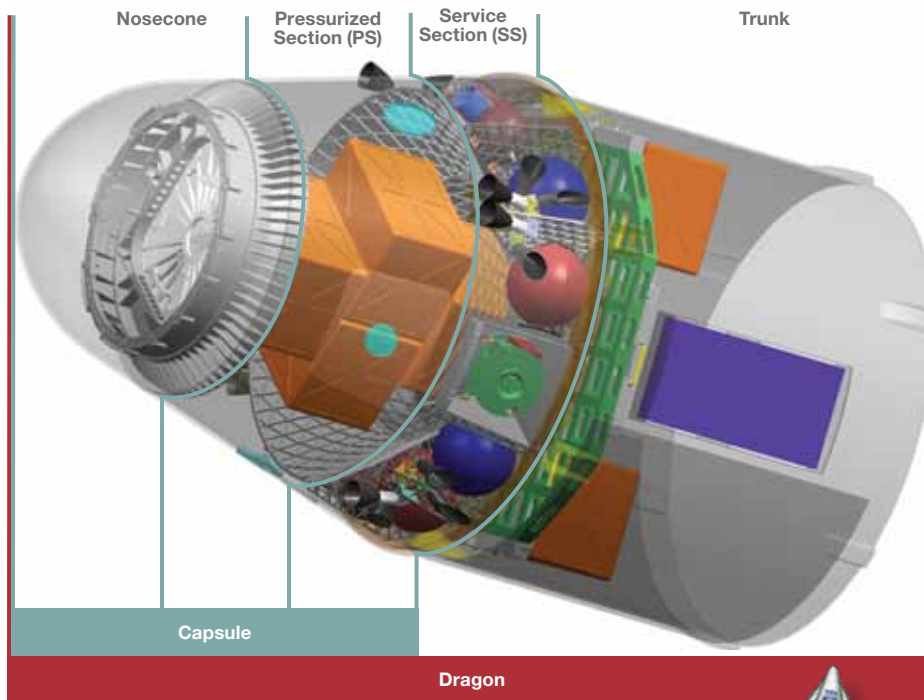
Falcon 9 and Dragon

SpaceX Exploration Technologies

The SpaceX missions are launched on a new launch vehicle called the Falcon 9 from Kennedy Space Center in Cape Canaveral, FL. The first stage is powered by nine SpaceX Merlin engines, and the second stage is also a single SpaceX Merlin engine. The spacecraft that will visit the ISS is called the Dragon.

The Dragon spacecraft is an automated logistical resupply vehicle designed to rendezvous with the ISS and then be grappled and berthed to Node 2 using the Space Station Remote Manipulator System (SSRMS).

The Dragon has a capsule for delivering pressurized cargo and is the element that will berth to Node 2. The Dragon also has what is called the “trunk,” which is attached to the capsule and provides for the delivery of unpressurized cargo to the ISS. Once the mission is complete, the Dragon will unberth from the ISS and the trunk will be jettisoned and destroyed during reentry into the atmosphere. The capsule will contain pressurized return cargo, survive reentry, and land in the ocean with the use of parachutes.



Falcon 9	
Height	48.1 m (157.80 ft)
Diameter	3.66 m (12 ft)
Mass at launch	313,000 kg (690,047 lb)
First stage thrust	3.80 MN (854,000 lb)
Second stage thrust	414 kN (93,000 lb)
Dragon	
Height	5.1 m (16.73 ft)
Diameter	3.66 m (12 ft)
Maximum Pressurized Cargo	
Up mass/volume	3,310 kg (7,297 lb) 6.8 m ³ (240 ft ³)
Down mass/volume	2,500 kg (5,512 lb) 6.8 m ³ (240 ft ³)
Maximum Unpressurized Cargo	
Up mass/volume	3,310 kg (7,297 lb) 14 m ³ (494 ft ³)
Down mass/volume	2,600 kg (5,732 lb) 14 m ³ Disposed (494 ft ³)
Payload volume	
Pressurized	10 m ³ (245 ft ³)
Unpressurized	14 m ³ (490 ft ³)

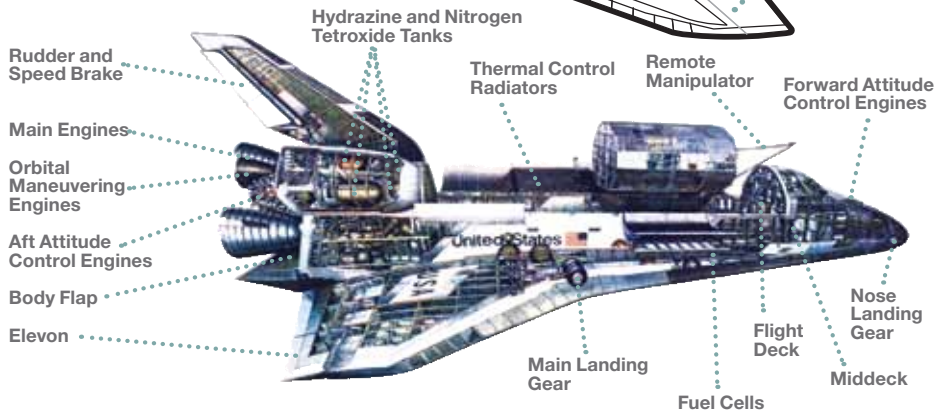
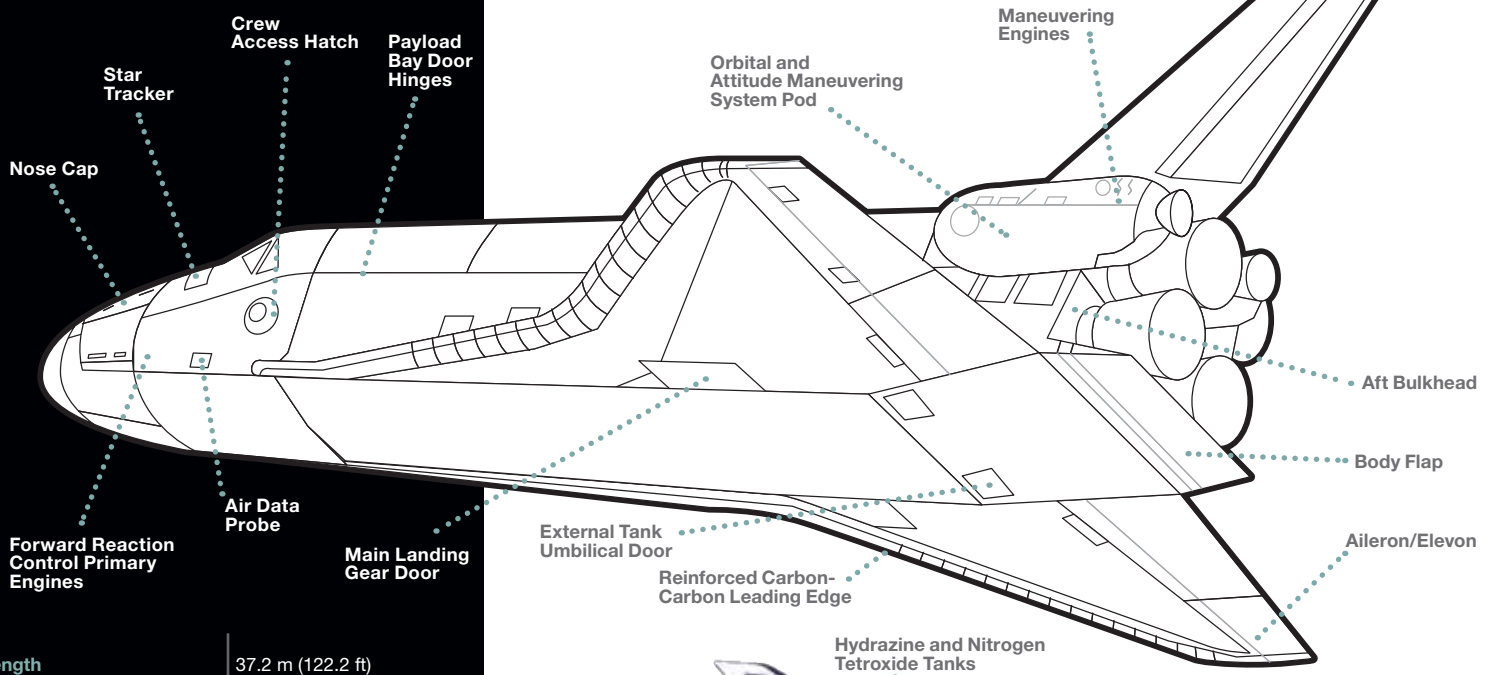




Space Shuttle Orbiter/ Columbia, Discovery, Atlantis, Endeavour

NASA/Boeing

The U.S. Space Shuttle provides Earth-to-orbit and return capabilities and in-orbit support. The diversity of its missions and customers is testimony to the adaptability of its design. The Space Shuttle was used to deliver most of the ISS modules and major components. It also provided crew rotation capability and science and maintenance cargo delivery, and it is the only vehicle that provided the capability to return significant payloads.



Length	37.2 m (122.2 ft)
Height	17.3 m (56.7 ft)
Wingspan	23.8 m (78 ft)
Typical mass	104,000 kg (230,000 lb)
Cargo capacity	16,000 kg (35,000 lb) (typical launch and return to ISS)
Pressurized habitable volume	74 m ³ (2,625 ft ³)
Mission length	7–16 days, typical
Number of crew	7, typical
Atmosphere	oxygen-nitrogen
Cargo Bay	
Length	18.3 m (60 ft)
Diameter	4.6 m (15 ft)



The Shuttle approaches the ISS carrying the Multi-Purpose Logistics Module (MPLM).

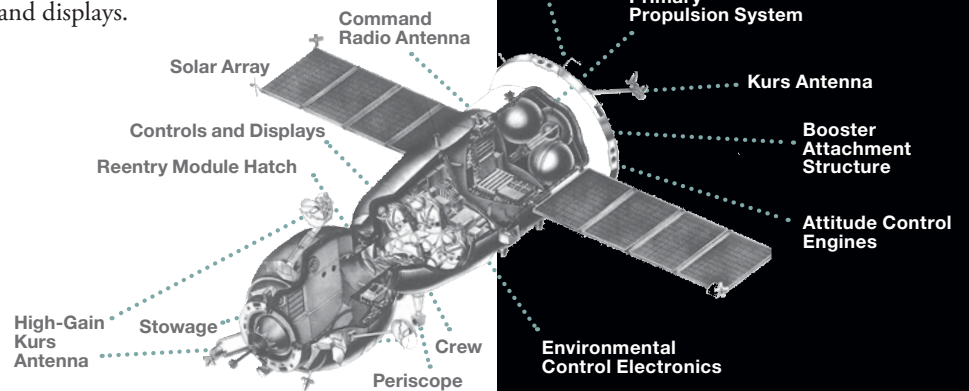
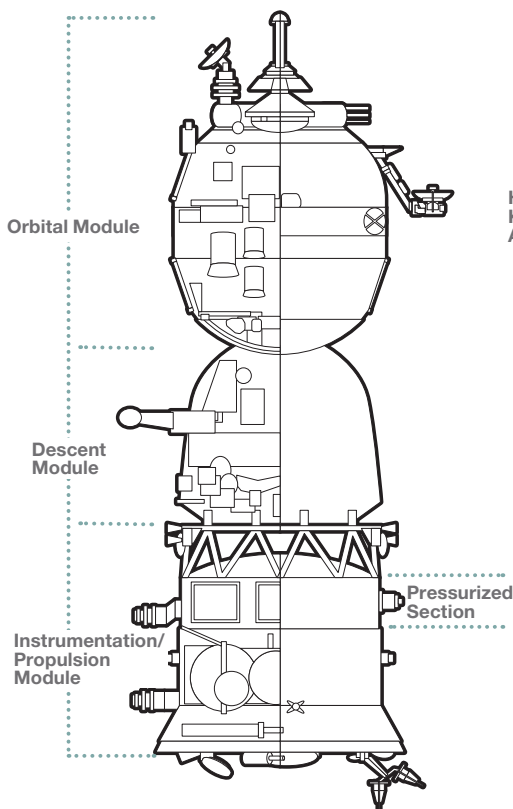


Shuttle berthed at the U.S. Lab, PMA 2.

Soyuz

Russian Federal Space Agency (Roscosmos)/S.P. Korolev Rocket and Space Corporation Energia (RSC Energia)

Soyuz spacecraft have been in use since the mid-1960s and have been upgraded periodically. Soyuz can support independently three suited crewmembers for up to 5.2 days and be docked to the ISS up to 200 days. The vehicle has an automatic docking system and may be piloted automatically or by a crewmember. The Soyuz TMA used for the ISS includes changes to accommodate larger and smaller crewmembers, an improved landing system, and digital electronic controls and displays.



Shannon Walker and Fyodor Yurchikhin, wearing Russian Sokol launch and entry suits in Soyuz TMA-19.

Mission Sequence



Launch and Aborts

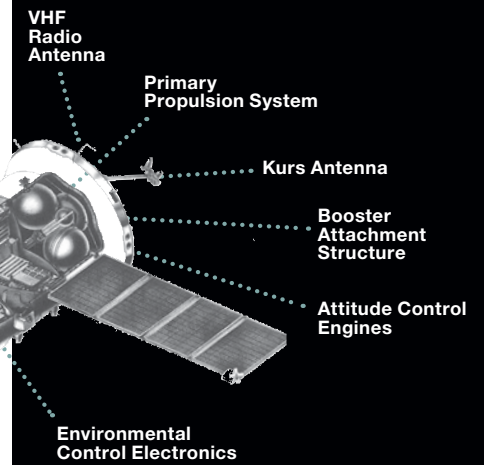
- 1 Launch
- 1A Abort using escape rocket
- 2 Escape rocket jettison, nose shroud separation (160 seconds in full)
- 3 Staging (186 seconds)
- 3A Abort by separation of Soyuz
- 4 Orbital velocity (526 seconds)

Return

- 5 Soyuz retrofire, orbital module separation, reentry module separation
- 6 Pilot parachute deploys
- 7 Drogue parachute deploys
- 7A Main parachute reefed
- 8 Main parachute fully deployed
- 9 Reentry heatshield jettison
- 10 Landing, retro rocket firing



Soyuz departs the ISS.



Launch mass	7,190 kg (15,851 lb)
Descent module	2,900 kg (6,393 lb)
Orbital module	1,300 kg (2,866 lb)
Instrumentation/propulsion module	2,600 kg (5,732 lb)
Delivered payload with two crewmembers with three crewmembers	230 kg (507 lb) 170 kg (375 lb)
Returned payload	50 kg (110 lb)
Length	7 m (22.9 ft)
Maximum diameter	2.7 m (8.9 ft)
Diameter of habitable modules	2.2 m (7.2 ft)
Solar array span	10.6 m (34.8 ft)
Volume of orbital module	6.5 m ³ (229.5 ft ³)
Volume of descent module	4 m ³ (141.3 ft ³)
Descent g-loads	4–5 g
Final landing speed	2 m/s (6.6 ft/s)

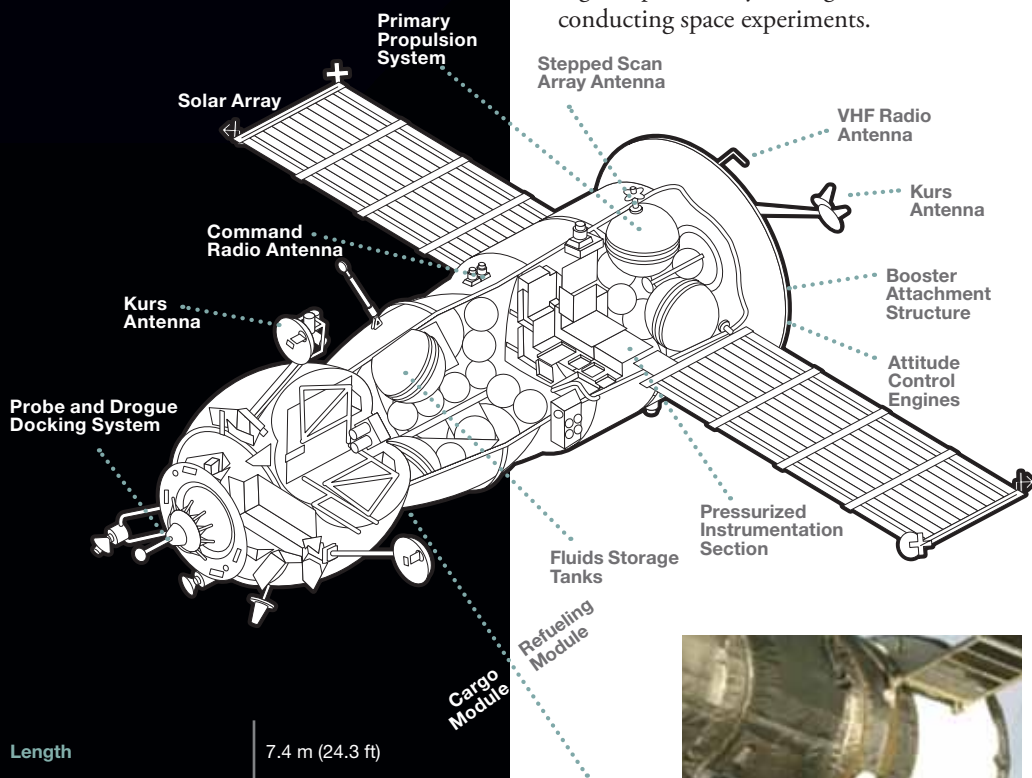
Progress approaches ISS.



Progress

Russian Federal Space Agency (Roscosmos)/S.P. Korolev Rocket and Space Corporation Energia (RSC Energia)

Progress is a resupply vehicle used for dry cargo, propellant, water, and gas deliveries to the ISS. Once docked to the ISS, Progress engines can boost the ISS to higher altitudes and control the orientation of the ISS in space. Typically, four to six Progress vehicles bring supplies to the ISS each year. Progress is based upon the Soyuz design, and it can either work autonomously or can be flown remotely by crewmembers aboard the ISS. After a Progress vehicle is filled with trash from the ISS, and after undocking and deorbit, it is incinerated in Earth's atmosphere at the end of its mission. During its autonomous flight (up to 30 days), Progress can serve as a remote free-flying research laboratory for conducting space experiments.



Progress cargo module interior.



Progress prelaunch processing.

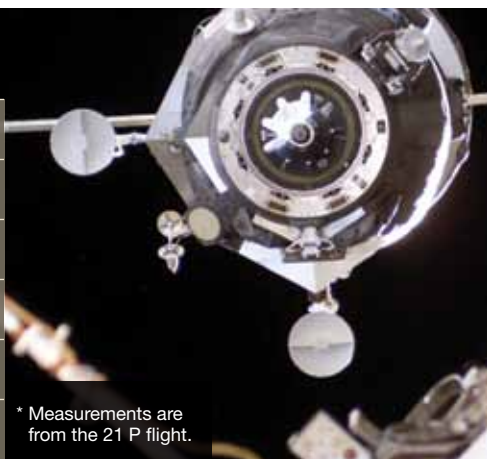


Progress prior to reentry.

Length	7.4 m (24.3 ft)
Maximum diameter	2.7 m (8.9 ft)
Span with solar arrays	10.7 m (35.1 ft)
Launch mass	7,440 kg (16,402 lb)
Cargo upload capacity	2,250 kg (4,960 lb)
Pressurized habitable volume	7.0 m ³ (247.2 ft ³)
Engine thrust	2,942 N (661 lbf)
Orbital life	6 mo
Dry cargo max	1,700 kg (3,748 lb)
Refueling propellant	870 kg (1,918 lb)

Cargo Load

	Maximum	Typical*
Dry cargo such as bags	1,800 kg (3,968 lb)	1,070 kg (2,360 lb)
Water	420 kg (925 lb)	300 kg (660 lb)
Air	50 kg (110 lb)	47 kg (103 lb)
Refueling propellant	1,700 kg (3,748 lb)	870 kg (1,918 lb)
Reboost propellant	250 kg (550 lb)	250 kg (550 lb)
Waste capacity	2,140 kg (4,718 lb)	2,000 kg (4,409 lb)



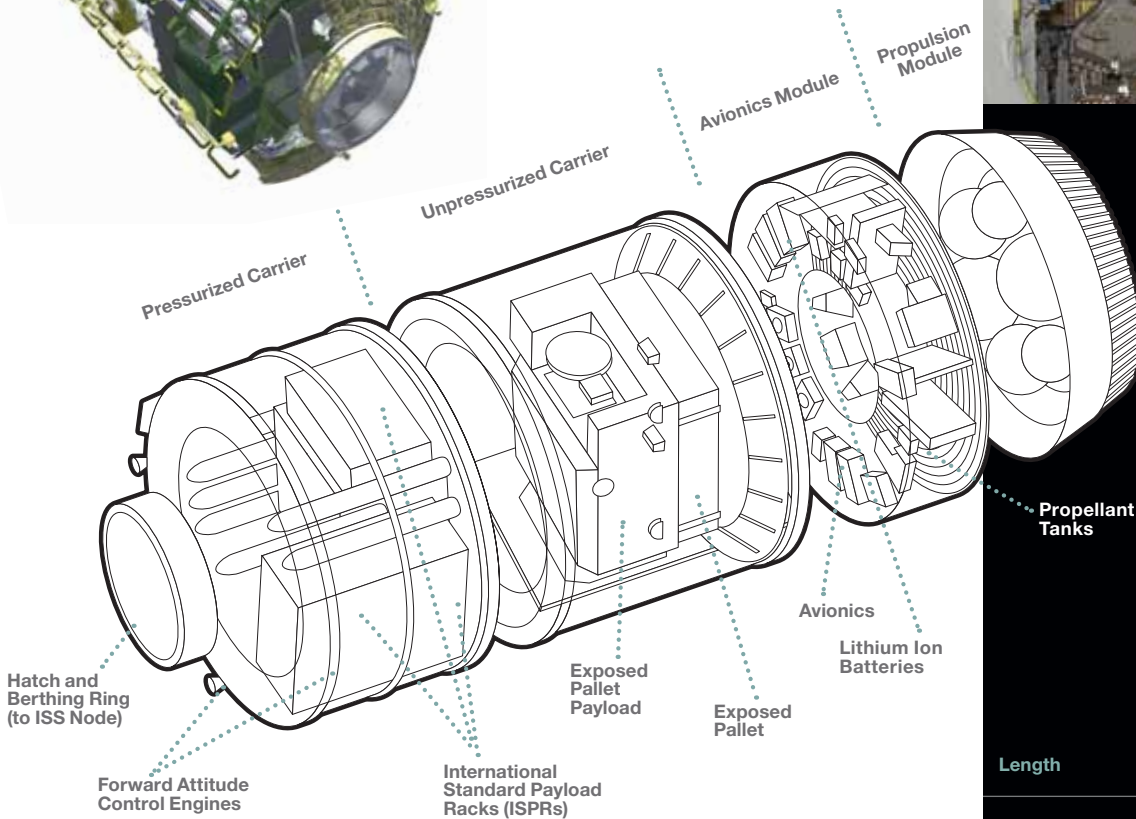
* Measurements are from the 21 P flight.

JAXA H-II Transfer Vehicle (HTV)

Japan Aerospace Exploration Agency (JAXA)/
Mitsubishi Heavy Industries, Ltd.

The H-II Transfer Vehicle is an autonomous logistical resupply vehicle designed to berth to the ISS using the Space Station Remote Manipulation System (SSRMS). HTV offers the capability to carry logistics materials in both its internal pressurized carrier and in an unpressurized carrier for exterior placement. It is launched on the H-II unmanned launch vehicle and can carry dry cargo, gas and water, and propellant.

After fresh cargo is unloaded at the ISS, the HTV is loaded with trash and waste products; after unberthing and deorbit, it is incinerated during reentry.



The HTV awaits grapple by the SSRMS.



Interior view of HTV pressurized carrier.



Canadarm2 unberths the HTV in preparation for its release from the ISS.



A close-up view of the HTV.

Length	9.2 m (30 ft)
Maximum diameter	4.4 m (14.4 ft)
Launch mass	16,500 kg (36,375 lb)
Cargo upload capacity	5,500 kg (12,125 lb)
Pressurized habitable volume	14 m ³ (495 ft ³)
Unpressurized volume	16 m ³ (565 ft ³)
Orbital life	6 mo

Automated Transfer Vehicle (ATV)

European Space Agency (ESA)/European Aeronautic Defence and Space Co. (EADS)

The European Space Agency Automated Transfer Vehicle is an autonomous logistical resupply vehicle designed to dock to the ISS and provide the crew with dry cargo, atmospheric gas, water, and propellant. After the cargo is unloaded, the ATV is reloaded with trash and waste products, undocks, and is incinerated during reentry.

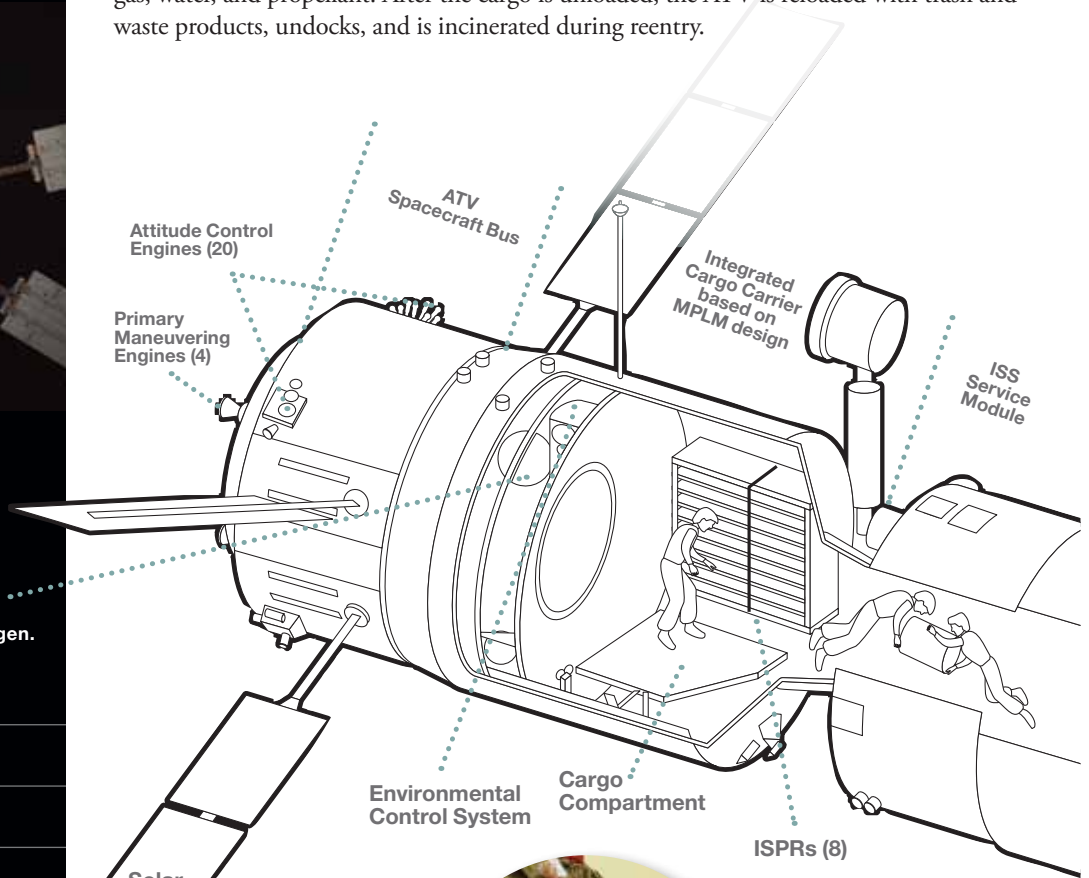


ATV late cargo access in Kourou, French Guiana, before launch.

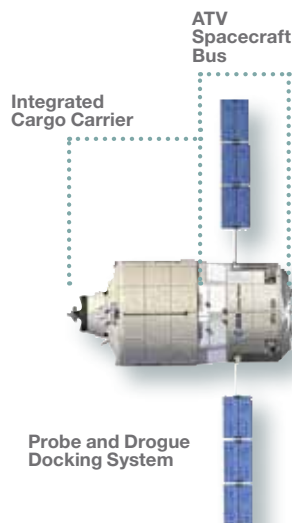


Image of ATV-1 as it approached the ISS in April 2008.

Titanium Tanks for carrying water, propellant, and oxygen.	
Length	10.3 m (33.8 ft)
Maximum diameter	4.5 m (14.8 ft)
Span across solar arrays	22.3 m (73.2 ft)
Launch mass	20,750 kg (45,746 lb)
Cargo upload capacity	7,667 kg (16,903 lb)
Engine thrust	1,960 N (441 lbf)
Orbital life	6 mo
Cargo Load	
Dry cargo such as bags	5,500 kg (12,125 lb)
Water	840 kg (1,852 lb)
Air (O ₂ , N ₂)	100 kg (220 lb)
Refueling propellant	860 kg (1,896 lb)
Reboost propellant	4,700 kg (10,360 lb)
Waste capacity	6,500 kg (14,330 lb)



Russian-built probe and drogue docking system.



The ATV during manufacture.

how the crew lives

The ISS has had a continuous human presence since November 2, 2000. In 2009, the number of astronauts living on board the space station increased from three to six.

The flight systems provide a safe, comfortable, and livable environment in which crewmembers can perform scientific research. These flight systems include habitation accommodations, environmental controls, medical and health support, and computing and data management.



Habitation

The habitable elements of the ISS are mainly a series of cylindrical modules. Accommodations—including the waste management compartment and toilet, the galley, individual crew sleep compartments, and some of the exercise facilities—are located in the Service Module (SM), Node 2, Node 3, and the U.S. Laboratory.



SM forward compartment.



Haircut in SM.



Shaving in SM.



Astronaut Shannon Walker uses a vacuum cleaner during housekeeping operations in the Kibo laboratory.



Playing keyboard in U.S. Lab.

progress

service module

fgb

node 3
node 1
airlock

u.s. lab

jem
node 2
columbus



Canadian astronaut Robert Thirsk is photographed wearing a sleep mask in a sleeping bag located in the JEM Pressurized Module (JPM).



Russian cosmonaut Alexander Skvortsov pictured in his crew quarters compartment.



SM transfer compartment.

Astronauts Peggy Whitson, Expedition 16 commander, and Pam Melroy, STS-120 commander, add the STS-120 crew patch in the Unity node to the growing collection of those representing Shuttle crews who have worked on the ISS. A location in the Unity node serves as one of the traditional posting sites for the patches.



Astronaut Nicole Stott exercises on the Combined Operational Load Bearing External Resistance Treadmill (COLBERT).



U.S. Lab Computer Workstation.



Canadian astronaut Bob Thirsk shaving.



Toilet in waste management compartment.



Astronaut Ed Liu prepares a meal in the SM's galley.



Stowed food trays in FGB.



Stowage container in FGB.



Interior of Node 1.



FGB Corridor and Stowage.



U.S./Joint Airlock.



Japanese astronaut Soichi Noguchi exercising on the Advanced Resistive Exercise Device (ARED) in Node 1.



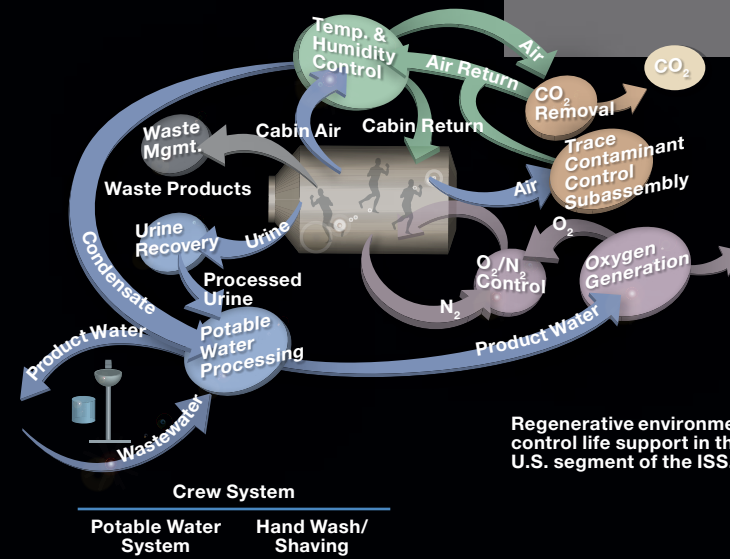
U.S. Lab Window.

Environmental Control and Life Support System (ECLSS)

Earth's natural life-support system provides the air we breathe, the water we drink, and other conditions that support life. For people to live in space, however, these functions must be performed by artificial means. The ECLSS includes compact and powerful systems that provide the crew with a comfortable environment in which to live and work.

The on-orbit ECLSS is supplemented by an assortment of resupply vehicles provided by the international partnership. The U.S. Space Shuttle delivers water (scavenged from the water produced by the Shuttle fuel cells and transferred across to ISS in Contingency Water Container (CWC) bags), high-pressure O₂ and N₂, and atmospheric gas. The Russian Progress and European Automated Transfer Vehicle (ATV) deliver water and atmospheric gas. The Japanese H-II Transfer Vehicle (HTV) delivers water in CWC bags.

The ISS program is currently reviewing a high-pressure gas delivery system for post-Shuttle retirement. The Nitrogen/Oxygen Resupply System (NORS) would provide capability to deliver high-pressure O₂ and N₂ on any vehicle with pressurized delivery capability, including U.S. Commercial Resupply System (CRS) vehicles.

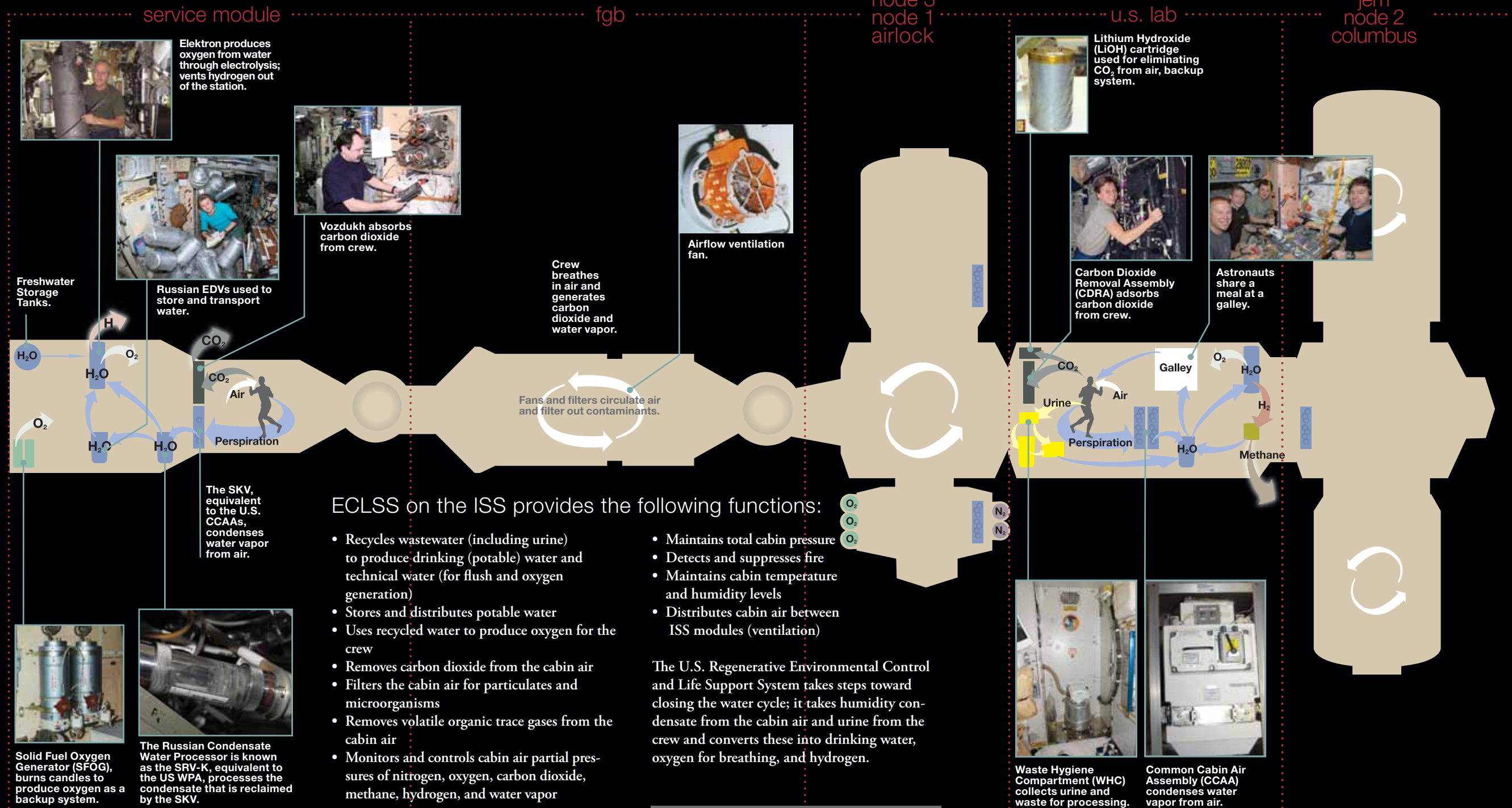
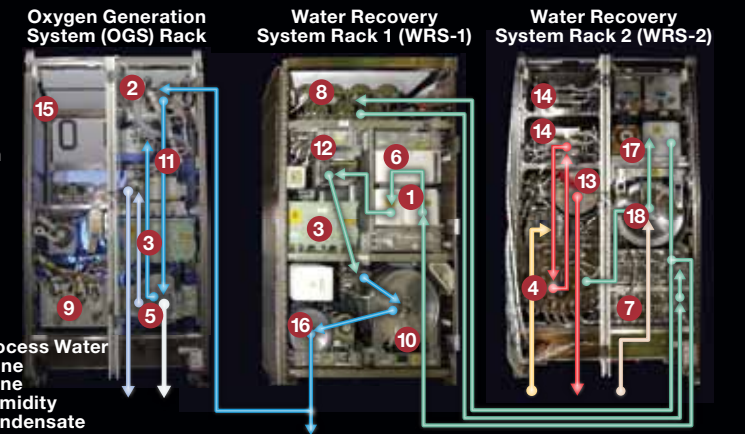


Regenerative environmental control life support in the U.S. segment of the ISS.

U.S. Regenerative Environmental Control and Life Support System (ECLSS)

- | | |
|---------------------------|---|
| 1 Catalytic Reactor | 12 Reactor Health Sensor |
| 2 Deionizer Beds | 13 Storage Tanks |
| 3 Digital Controller | 14 Urine Processor Pumps |
| 4 Distillation Assembly | 15 Volume reserved for later CO ₂ Reduction System |
| 5 Electrolysis Cell Stack | 16 Water Processor Delivery Pump |
| 6 Gas Separator | 17 Water Processor Pump & Separator |
| 7 Multifiltration Beds | 18 Water Processor Wastewater Tank |
| 8 Particulate Filter | |
| 9 Power Supply | |
| 10 Product Water Tank | |
| 11 Pumps & Valves | |

- | | |
|-------------------------------|-----------------------|
| = Oxygen | = Process Water |
| = Hydrogen (vented overboard) | = Urine |
| = Potable Water | = Brine |
| | = Humidity Condensate |



Elektron produces oxygen from water through electrolysis; vents hydrogen out of the station.



Russian EDVs used to store and transport water.

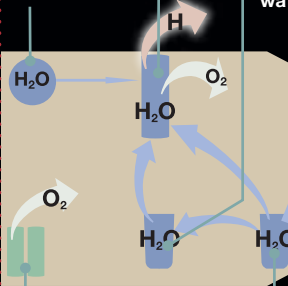


Vozdukh absorbs carbon dioxide from crew.



Airflow ventilation fan.

Freshwater Storage Tanks.



The SKV, equivalent to the U.S. CCAAs, condenses water vapor from air.



Solid Fuel Oxygen Generator (SFOG), burns candles to produce oxygen as a backup system.



The Russian Condensate Water Processor is known as the SRV-K, equivalent to the US WPA, processes the condensate that is reclaimed by the SKV.

ECLSS on the ISS provides the following functions:

- Recycles wastewater (including urine) to produce drinking (potable) water and technical water (for flush and oxygen generation)
- Stores and distributes potable water
- Uses recycled water to produce oxygen for the crew
- Removes carbon dioxide from the cabin air
- Filters the cabin air for particulates and microorganisms
- Removes volatile organic trace gases from the cabin air
- Monitors and controls cabin air partial pressures of nitrogen, oxygen, carbon dioxide, methane, hydrogen, and water vapor
- Maintains total cabin pressure
- Detects and suppresses fire
- Maintains cabin temperature and humidity levels
- Distributes cabin air between ISS modules (ventilation)

The U.S. Regenerative Environmental Control and Life Support System takes steps toward closing the water cycle; it takes humidity condensate from the cabin air and urine from the crew and converts these into drinking water, oxygen for breathing, and hydrogen.



Lithium Hydroxide (LiOH) cartridge used for eliminating CO₂ from air, backup system.



Carbon Dioxide Removal Assembly (CDRA) adsorbs carbon dioxide from crew.



Astronauts share a meal at a galley.



Waste Hygiene Compartment (WHC) collects urine and waste for processing.



Common Cabin Air Assembly (CCAA) condenses water vapor from air.

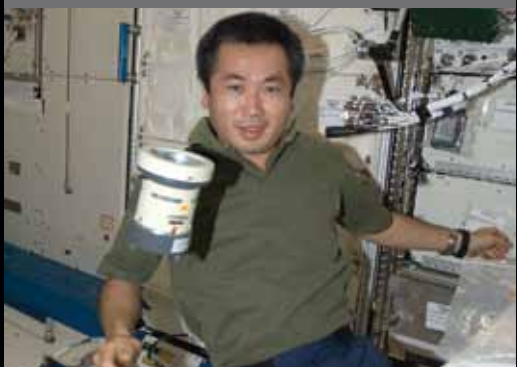
Crew Health Care System (CHeCS)/Integrated Medical System

The Crew Health Care System (CHeCS)/Integrated Medical System is a suite of hardware on the ISS that provides the medical and environmental capabilities necessary to ensure the health and safety of crewmembers during long-duration missions. CHeCS is divided into three subsystems:

Countermeasures System (CMS)—The CMS provides the equipment and protocols for the performance of daily and alternative regimens (e.g., exercise) to mitigate the deconditioning effects of living in a microgravity environment. The CMS also monitors crewmembers during exercise regimens, reduces vibrations during the performance of these regimens, and makes periodic fitness evaluations possible.

Environmental Health System (EHS)—The EHS monitors the atmosphere for gaseous contaminants (i.e., from nonmetallic materials off-gassing, combustion products, and propellants), microbial contaminants (i.e., from crewmembers and station activities), water quality, acoustics, and radiation levels.

Health Maintenance System (HMS)—The HMS provides in-flight life support and resuscitation, medical care, and health monitoring capabilities.



A Microbial Air Sampler (MAS) floats in front of Japanese astronaut Koichi Wakata as he performs a Surface Sample Kit (SSK) collection and incubation.



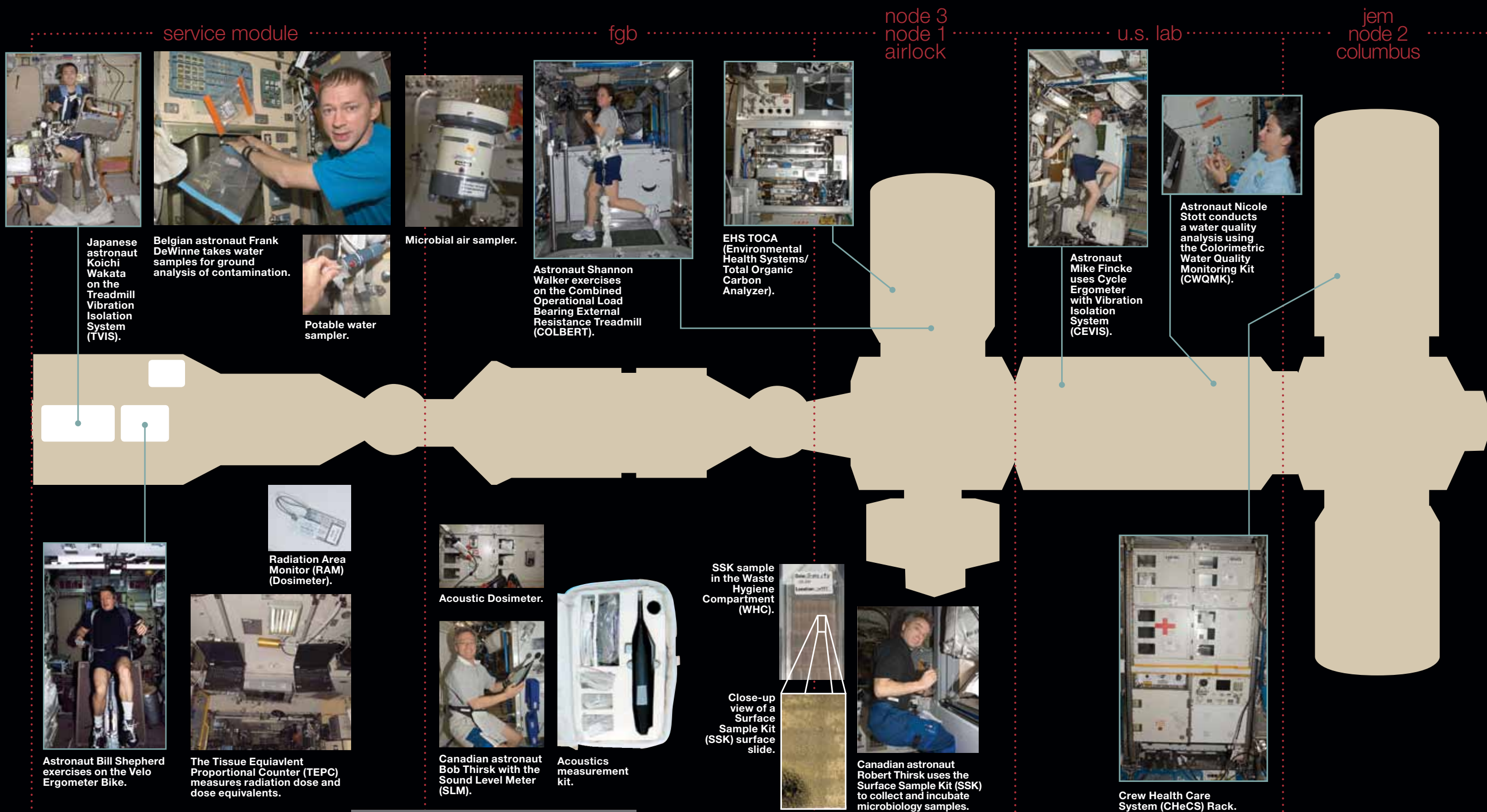
Astronaut Leland Melvin exercises on the Advanced Resistive Exercise Device (ARED).



Cosmonaut Roman Romanenko and Astronaut Michael Barratt perform a detailed checkout and inspection of the HMS CMRS (Health Maintenance System/Crew Medical Restraint System) in the U.S. Lab. The boardlike CMRS allows strapping down a patient on the board with a harness for medical attention by the CMO who is also provided with restraints around the device.



Defibrillator.



S0, Extravehicular Charged Particle Directional Spectrometer (EVCPS).



Astronaut Bill Shepherd exercises on the Velo Ergometer Bike.



The Tissue Equivalent Proportional Counter (TEPC) measures radiation dose and dose equivalents.



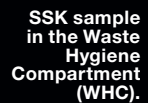
Acoustic Dosimeter.



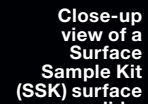
Canadian astronaut Bob Thirsk with the Sound Level Meter (SLM).



Acoustics measurement kit.



SSK sample in the Waste Hygiene Compartment (WHC).



Close-up view of a Surface Sample Kit (SSK) surface slide.



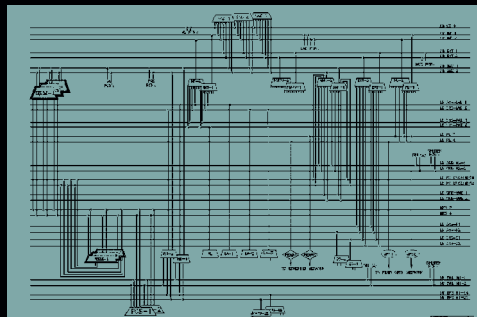
Canadian astronaut Robert Thirsk uses the Surface Sample Kit (SSK) to collect and incubate microbiology samples.



Crew Health Care System (CHeCS) Rack.

Computers and Data Management

The system for storing and transferring information essential to operating the ISS has been functioning since the first module was placed on orbit. From a single module to a large complex of elements from many international partners, the system provides control of the ISS from the U.S., Russian, Canadian, European, and Japanese segments.



- Data bus architecture consists of:
- 100+ MIL-STD-1553B data buses
 - 60+ computers into which software can be loaded as necessary
 - 1,200+ remote terminals
 - 190 payload remote terminals
 - 600+ international partner and firmware controller devices
 - 90+ unique types of remote devices



Maneuvering Truss Segments into Place at SSRMS Workstation.



SSRMS Control and Robotics Workstations.



Multiplexer/Demultiplexer Mass Memory Unit (MMU) Processor Data Cards in U.S. Lab.

progress

service module

fgb

node 3
node 1
airlock

u.s. lab

jem
node 2
columbus



Laptop (in SM crew quarters).



Primary Command Workstation in SM.



Crew uses Progress Remote Control workstation in SM.



Multiplexer/Demultiplexer (computer).



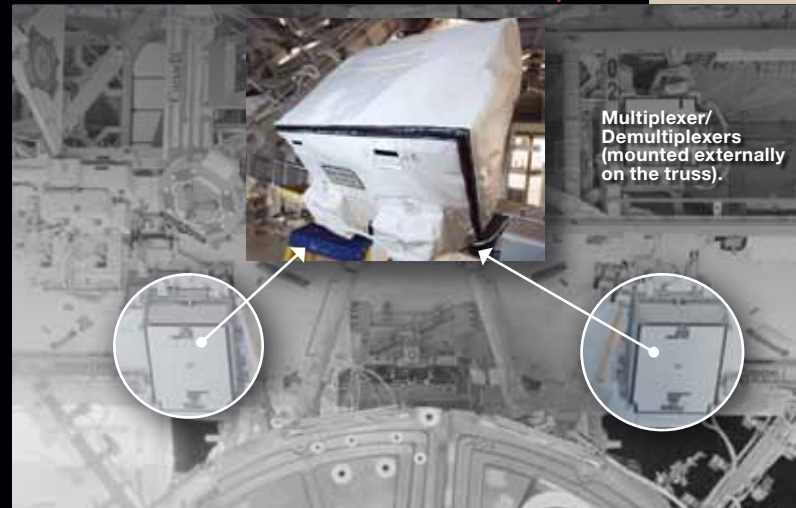
Laptop and TVIS Control (located near galley).



Russian Segment Workstations.



TORU Remote Progress Docking Workstation.



Multiplexer/Demultiplexers (mounted externally on the truss).



Human Research Facility Workstation.

how it works

The operations of the ISS are based on a core functional infrastructure. The Integrated Truss Assembly is the backbone of the ISS, providing power, thermal controls, navigation, propulsion, and communications. Each capability is vital to providing the crew with a safe, practical, and efficient environment for performing science.

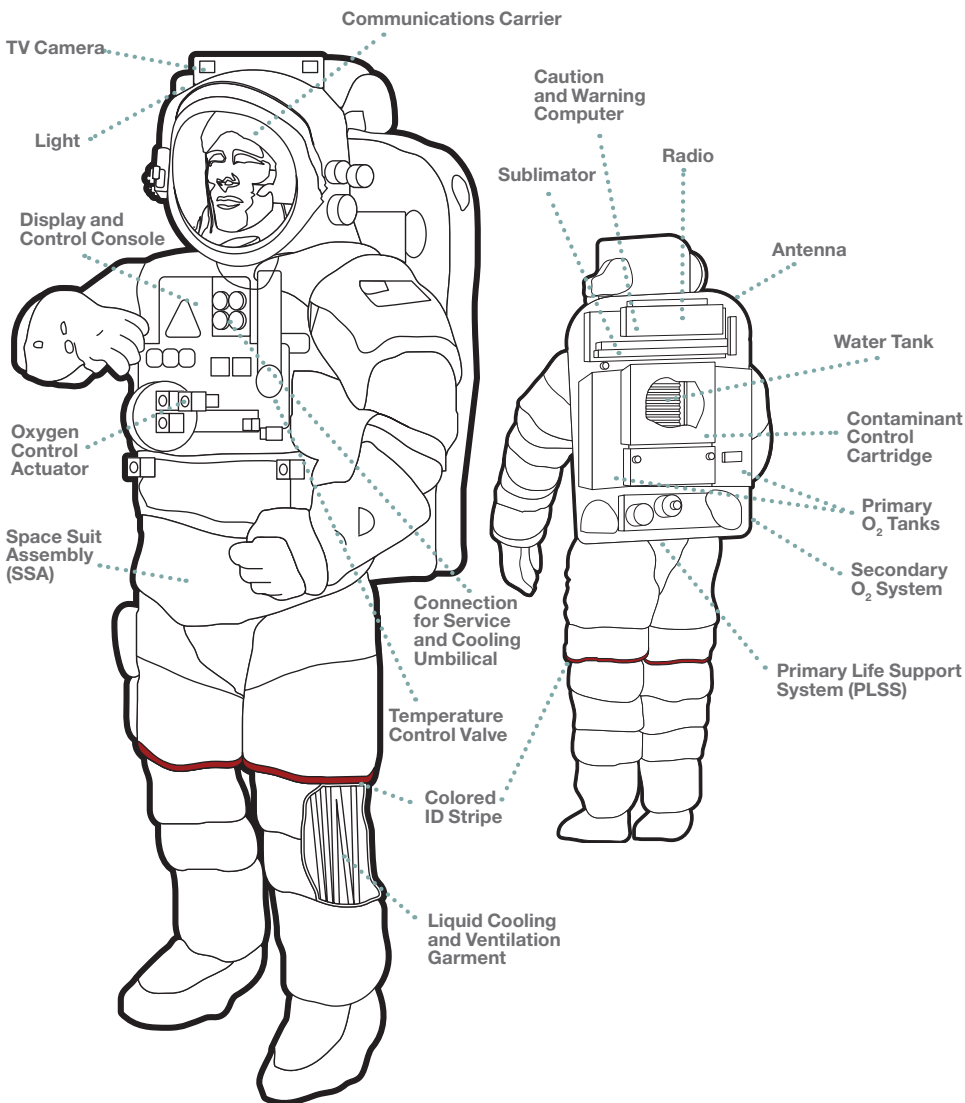
Maintenance and operations outside the ISS are accomplished with extravehicular activities (EVAs), or spacewalks, and robotics. Operational lessons in spacesuit maintainability, training, and ground support may prove critical for longer duration human exploration missions.



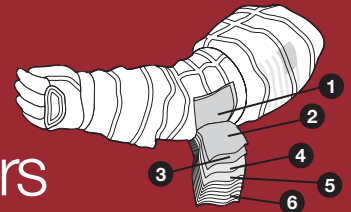
Extravehicular Mobility Unit (EMU)

NASA/Hamilton Sundstrand/ILC Dover

The EMU provides a crewmember with life support and an enclosure that enables EVA. The unit consists of two major subsystems: the Primary Life Support Subsystem (PLSS) and the Space Suit Assembly (SSA). The EMU provides atmospheric containment, thermal insulation, cooling, solar radiation protection, and micrometeoroid/orbital debris (MMOD) protection.

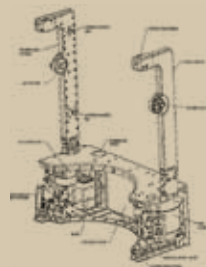


Suit Layers



- 1 Thermal Micrometeoroid Garment (TMG). Cover: Ortho/KEVLAR® reinforced with GORE-TEX®.
- 2 TMG Insulation. Five to seven layers of aluminized Mylar® (more layers on arms and legs).
- 3 TMG liner. Neoprene-coated nylon ripstop.
- 4 Pressure garment cover. Restraint: Dacron®.
- 5 Pressure garment bladder. Urethane-coated nylon oxford fabric.
- 6 Liquid cooling garment. Neoprene tubing.

The Simplified Aid For EVA Rescue (SAFER) provides a compressed nitrogen-powered backpack that permits a crewmember to maneuver independently of the ISS. Its principal use is that it allows a crewmember to maneuver back to the station if he or she becomes detached from the ISS.



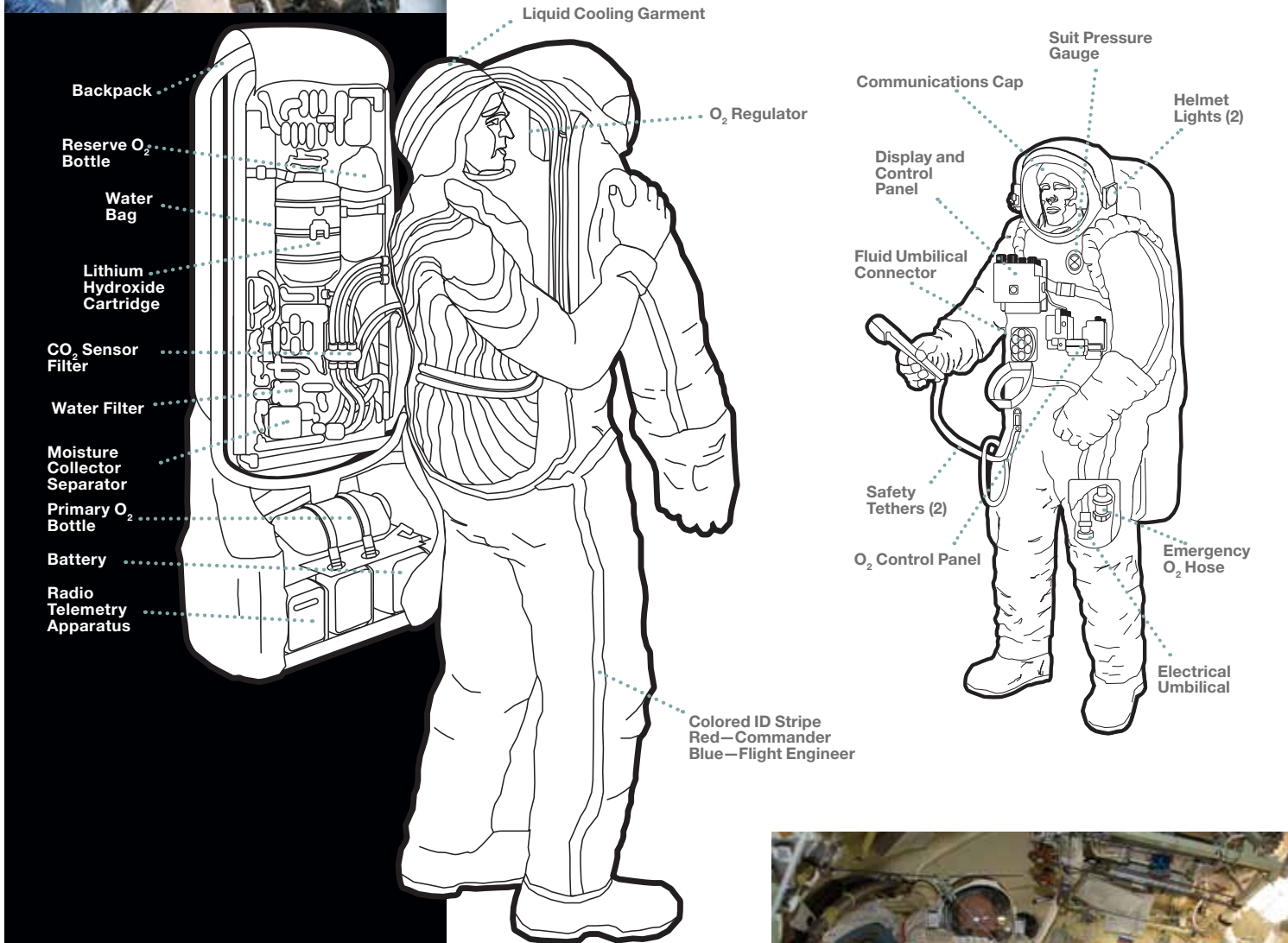
Suit's nominal pressure	0.3 atm (4.3 psi)
Atmosphere	100% oxygen
Primary oxygen tank pressure	900 psi
Secondary oxygen tank pressure	6,000 psi (30-min backup supply)
Maximum EVA duration	8 h
Mass of entire EMU	178 kg (393 lb)
Suit life	30 yr



Orlan Spacesuit

Russian Federal Space Agency (Roscosmos)/Science Production Enterprise Zvezda

The Orlan-MK spacesuit is designed to protect an EVA crewmember from the vacuum of space, ionizing radiation, solar energy, and micrometeoroids. The main body and helmet of the suit are integrated and are constructed of aluminum alloy. Arms and legs are made of a flexible fabric material. Crewmembers enter from the rear via the backpack door, which allows rapid entry and exit without assistance. The Orlan-MK spacesuit is a “one-size-fits-most” suit.



Suit's nominal pressure	0.4 atm (5.8 psi)
Atmosphere	100% oxygen
Maximum EVA duration	7 h
Mass of entire EMU	108 kg (238 lb)
Suit life	15 EVAs or 4 years without return to Earth



Expedition 22 cosmonauts Oleg Kotov (left) and Maxim Suraev check out their Orlan suits in preparation for a spacewalk.

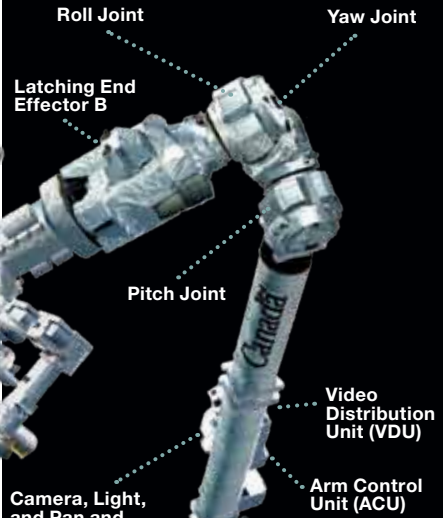
Mobile Servicing System (MSS)

Space Station Remote Manipulator System (SSRMS)
 Special Purpose Dexterous Manipulator (SPDM/Dextre)
 Mobile Base System (MBS)
 Canadian Space Agency (CSA)

The Mobile Servicing System (MSS) is a sophisticated robotics suite that plays a critical role in the assembly, maintenance, and resupply of the ISS. The MSS Operations Complex in Saint Hubert, Quebec, is the ground base for the MSS, which is composed of three robots that can work together or independently.



SSRMS during testing.



The MSS has three parts:



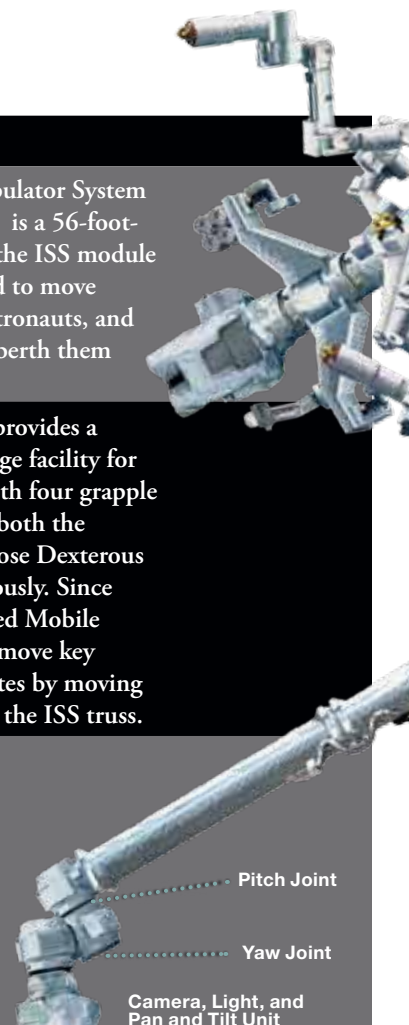
The Space Station Remote Manipulator System (SSRMS), known as Canadarm2, is a 56-foot-long robotic arm that assembled the ISS module by module in space. It is also used to move supplies, equipment, and even astronauts, and captures free-flying spacecraft to berth them to the ISS.



The Mobile Base System (MBS) provides a movable work platform and storage facility for astronauts during spacewalks. With four grapple fixtures, it can serve as a base for both the Canadarm2 and the Special Purpose Dexterous Manipulator (SPDM) simultaneously. Since it is mounted on the U.S.-provided Mobile Transporter (MT), the MBS can move key elements to their required worksites by moving along a track system mounted on the ISS truss.



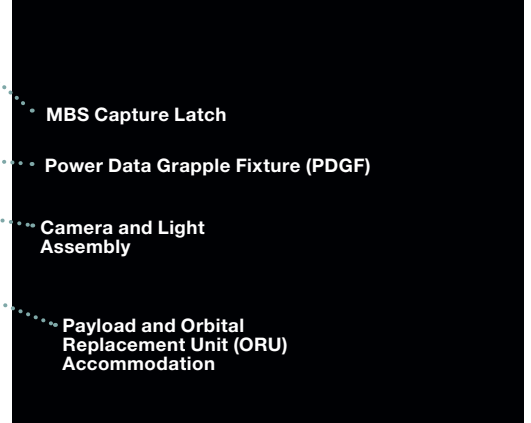
The Special Purpose Dexterous Manipulator (SPDM), also known as Dextre, performs routine maintenance on the ISS. Equipped with lights, video equipment, a tool platform, and four tool holders, Dextre's dual-arm design and precise handling capabilities can reduce the need for spacewalks.



	SSRMS	MBS	SPDM
Length/height	17.6 m (57 ft)		3.5 m (11.4 ft)
Maximum diameter	.36 m (1.2 ft)		.88 m (2.9 ft)
Dimensions		5.7 × 4.5 × 2.9 m (18.5 × 14.6 × 9.4 ft)	
Mass	1,497 kg (3,300 lb)	1,450 kg (3,196 lb)	1,662 kg (3,664 lb)
Degrees of freedom	7		

- MBS Capture Latch
- Power Data Grapple Fixture (PDGF)
- Camera and Light Assembly
- Payload and Orbital Replacement Unit (ORU) Accommodation

Canadian Remote Power Controller Module (CRPCM)



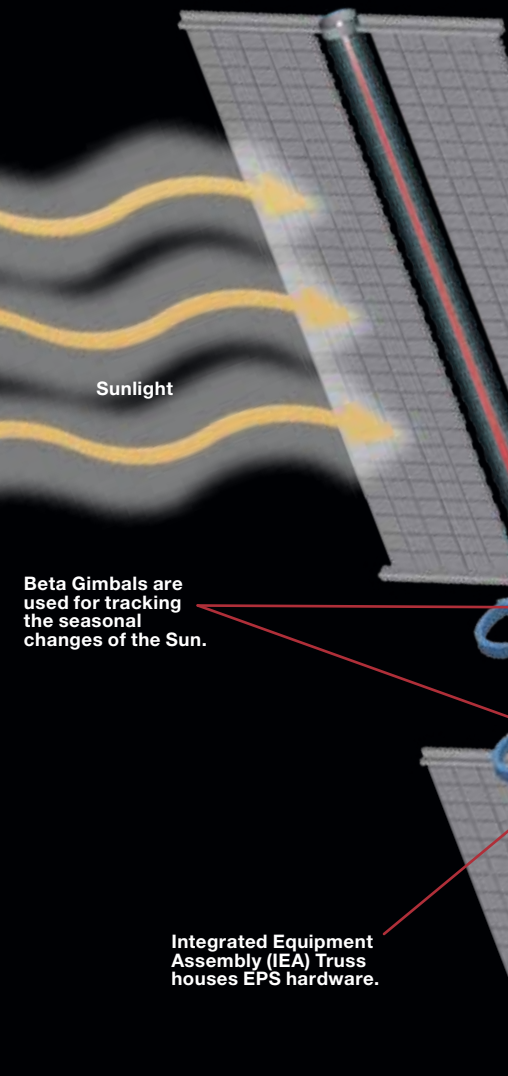
Electrical Power System (EPS)

The EPS generates, stores, and distributes power and converts and distributes secondary power to users.

Each Solar Array Wing (SAW) has 2 blankets of 32,800 solar cells, converting sunlight to DC power and producing a maximum of 31 kW at the beginning of its life and degrading to 26 kW after 15 years. Each cell is approximately 14% efficient, which was state-of-the-art at the time of design.



Crewmember Mike Fincke replaces the Remote Power Controller Module (RPCM) on the S0 Truss.



Sunlight

Beta Gimbals are used for tracking the seasonal changes of the Sun.

Integrated Equipment Assembly (IEA) Truss houses EPS hardware.

Sequential Shunt Unit (SSU) maintains constant voltage at 160 V.

Direct Current (DC) Switching Unit (DCSU) routes power from the solar array to the MBSUs in the S0 Truss that control power to different ISS locations.

Nickel-Hydrogen Batteries store electrical energy for use during the night. They will be replaced over time with Lithium Ion batteries. The Battery Charge Discharge Unit (BCDU) controls each battery's charge.

Photovoltaic Radiator circulates cooling fluid to maintain EPS/battery temperature.

Solar (Array) Alpha Rotation Joint (SARJ) tracks the Sun throughout Earth orbit.

Main Bus Switching Units (MBSUs) route power to proper locations in the ISS.

Primary Electric Power (160 V DC).

Power coming in from arrays and batteries

Electronics Control Unit (ECU) controls pointing of solar arrays.

Remote Power Controllers (RPCs) control the flow of electric power to users.

DC-to-DC Converter Units (DDCUs) convert primary 160 V power to secondary 124 V power. Some are located on the truss and some are located in modules.

U.S. Laboratory



Crewmember Mike Fincke holds an RPCM in the Quest Airlock. It was later used to replace an RPCM on the S0 Truss.



Astronaut Scott Parazynski, anchored to the Articulating Portable Foot Restraint (APFR) on the Orbiter Boom Sensor System (OBSS), assesses repair work on the P6 4B Solar Array Wing (SAW) as the array is deployed during an extravehicular activity (EVA).

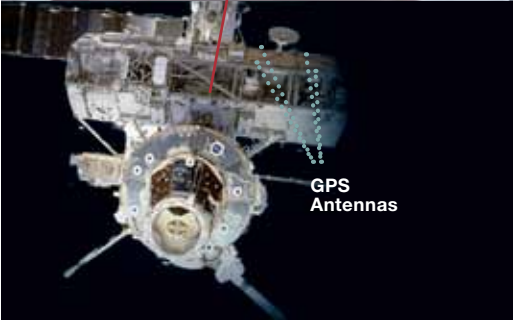
Guidance, Navigation, and Control (GN&C)

The ISS is a large, free-flying vehicle. The attitude or orientation of the ISS with respect to Earth and the Sun must be controlled; this is important for maintaining thermal, power, and microgravity levels, as well as for communications.

The GN&C system tracks the Sun, communications and navigation satellites, and ground stations. Solar arrays, thermal radiators, and communications antennas aboard the ISS are pointed using the tracking information.

The preferred method of attitude control is the use of Control Moment Gyroscopes (CMGs), sometimes called gyrodynes in other programs, mounted on the Z1 Truss segment. CMGs are 98-kilogram (220-pound) steel wheels that spin at 6,600 revolutions per minute (rpm). The high-rotation velocity and large mass allow a considerable amount of angular momentum to be stored. Each CMG has gimbals and can be repositioned to any attitude. As the CMG is repositioned, the resulting force causes the ISS to move. Using multiple CMGs permits the ISS to be moved to new positions or permits the attitude to be held constant. The advantages of this system are that it relies on electrical power generated by the solar arrays and that it provides smooth, continuously variable attitude control. CMGs are, however, limited in the amount of angular momentum they can provide and the rate at which they can move the station. When CMGs can no longer provide the requisite energy, rocket engines are used.

GPS antenna on S0 Truss.



GPS Antennas



Control Moment Gyroscopes on the Z1 Truss.



Control Moment Gyroscope gimbals used for orienting the ISS.

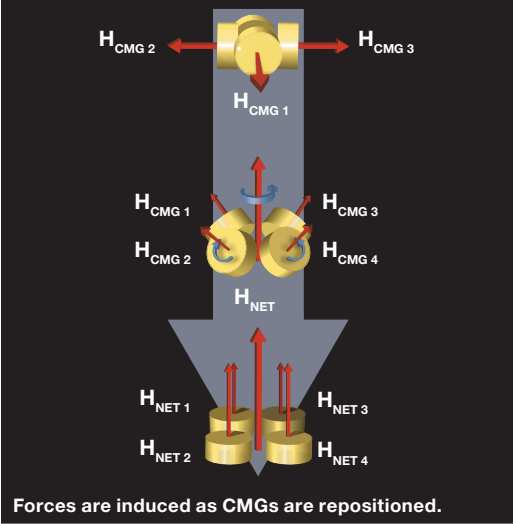
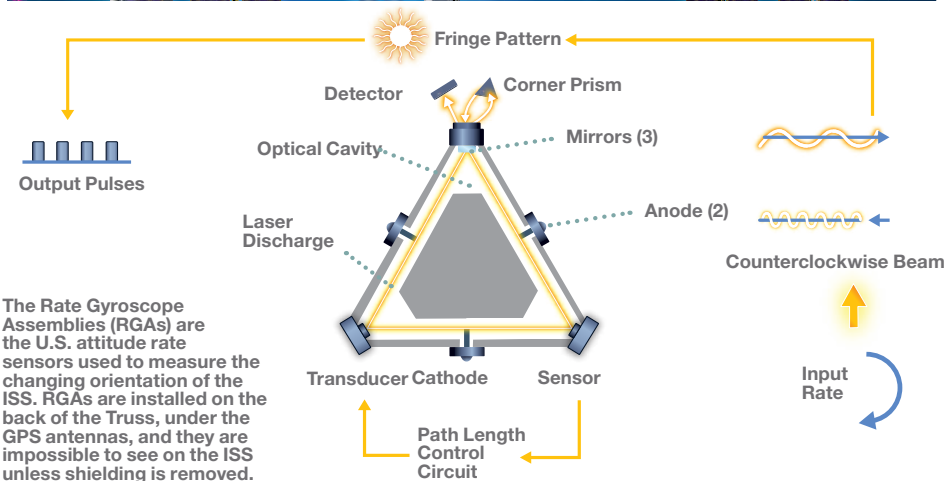
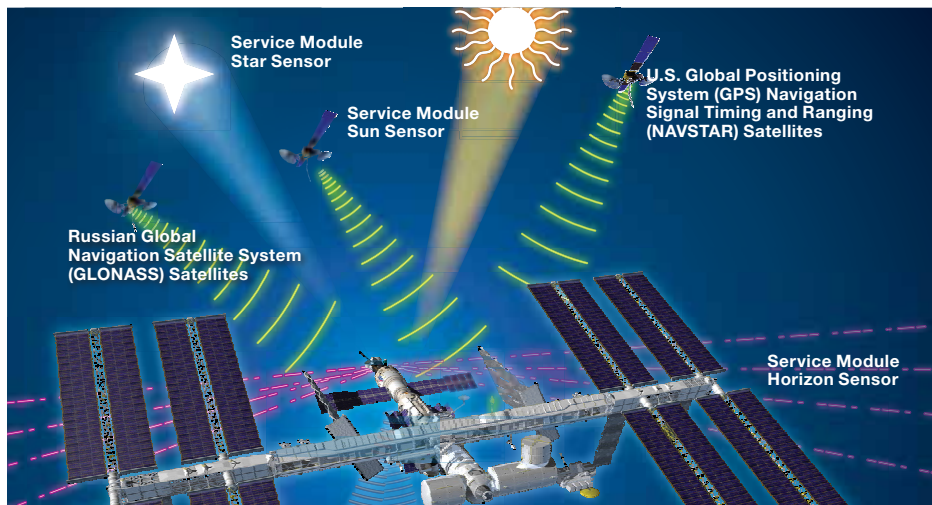
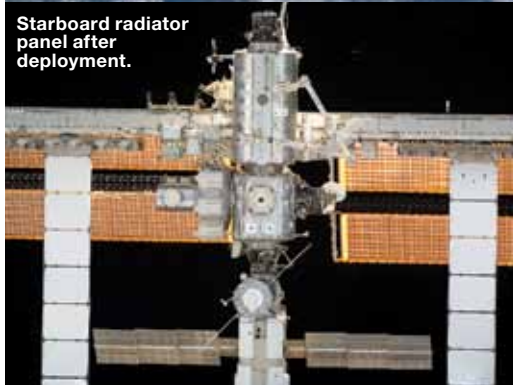




Image with all radiators deployed.



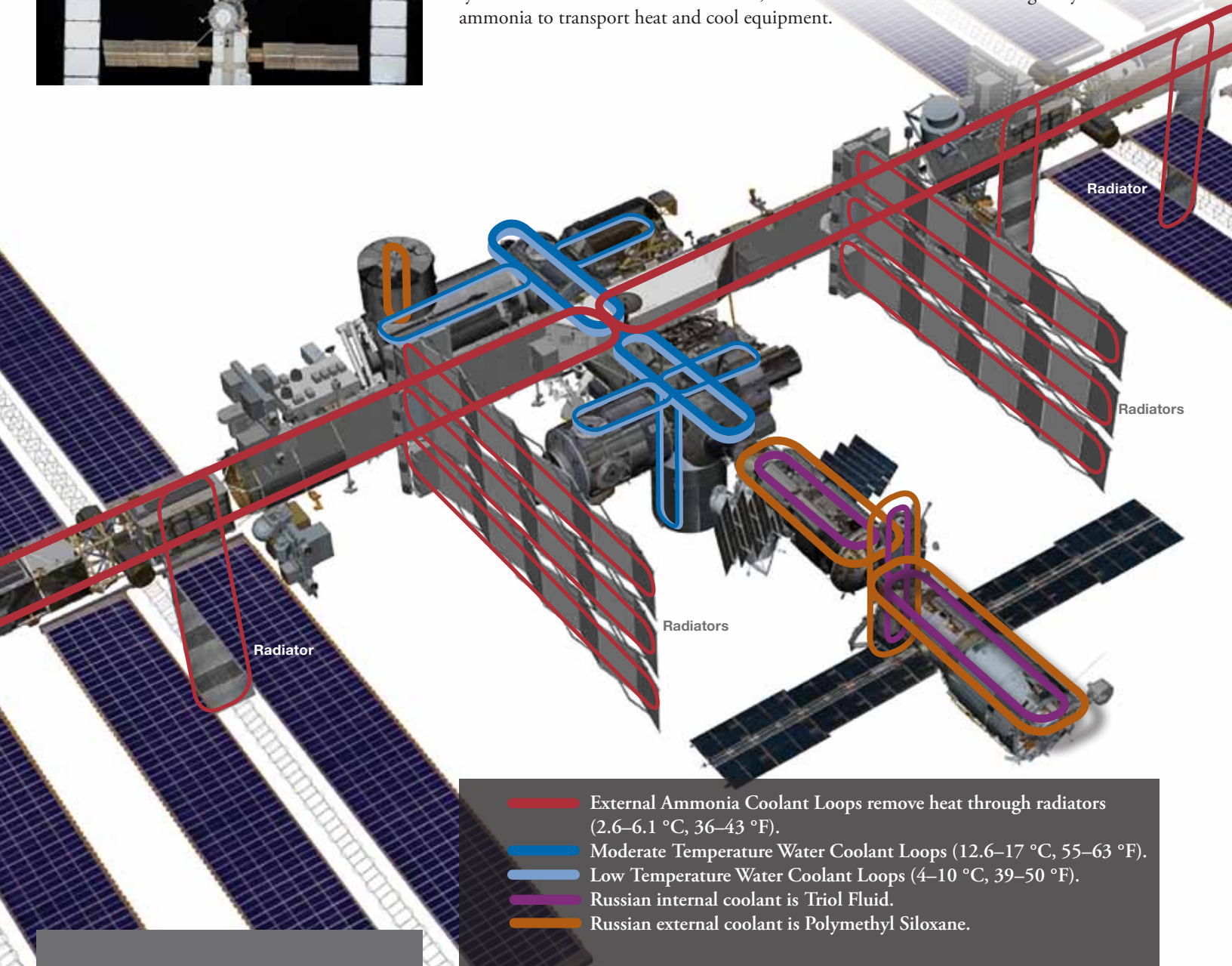
Starboard radiator panel after deployment.

Thermal Control System (TCS)

The TCS maintains ISS temperatures within defined limits. The four components used in the Passive Thermal Control System (PTCS) are insulation, surface coatings, heaters, and heat pipes.

The Active Thermal Control System (ATCS) is required when the environment or the heat loads exceed the capabilities of the PTCS. The ATCS uses mechanically pumped fluids in closed-loop circuits to perform three functions: heat collection, heat transportation, and heat rejection.

Inside the habitable modules, the internal ATCS uses circulating water to transport heat and cool equipment. Cabin air is used to cool the crewmembers and much of the electrical equipment. The air passes heat to the water-based cooling system in the air conditioner, which also collects water from the humidity in the air for use by the life support system. Outside the habitable modules, the external ATCS uses circulating anhydrous ammonia to transport heat and cool equipment.



- External Ammonia Coolant Loops remove heat through radiators (2.6–6.1 °C, 36–43 °F).
- Moderate Temperature Water Coolant Loops (12.6–17 °C, 55–63 °F).
- Low Temperature Water Coolant Loops (4–10 °C, 39–50 °F).
- Russian internal coolant is Triol Fluid.
- Russian external coolant is Polymethyl Siloxane.

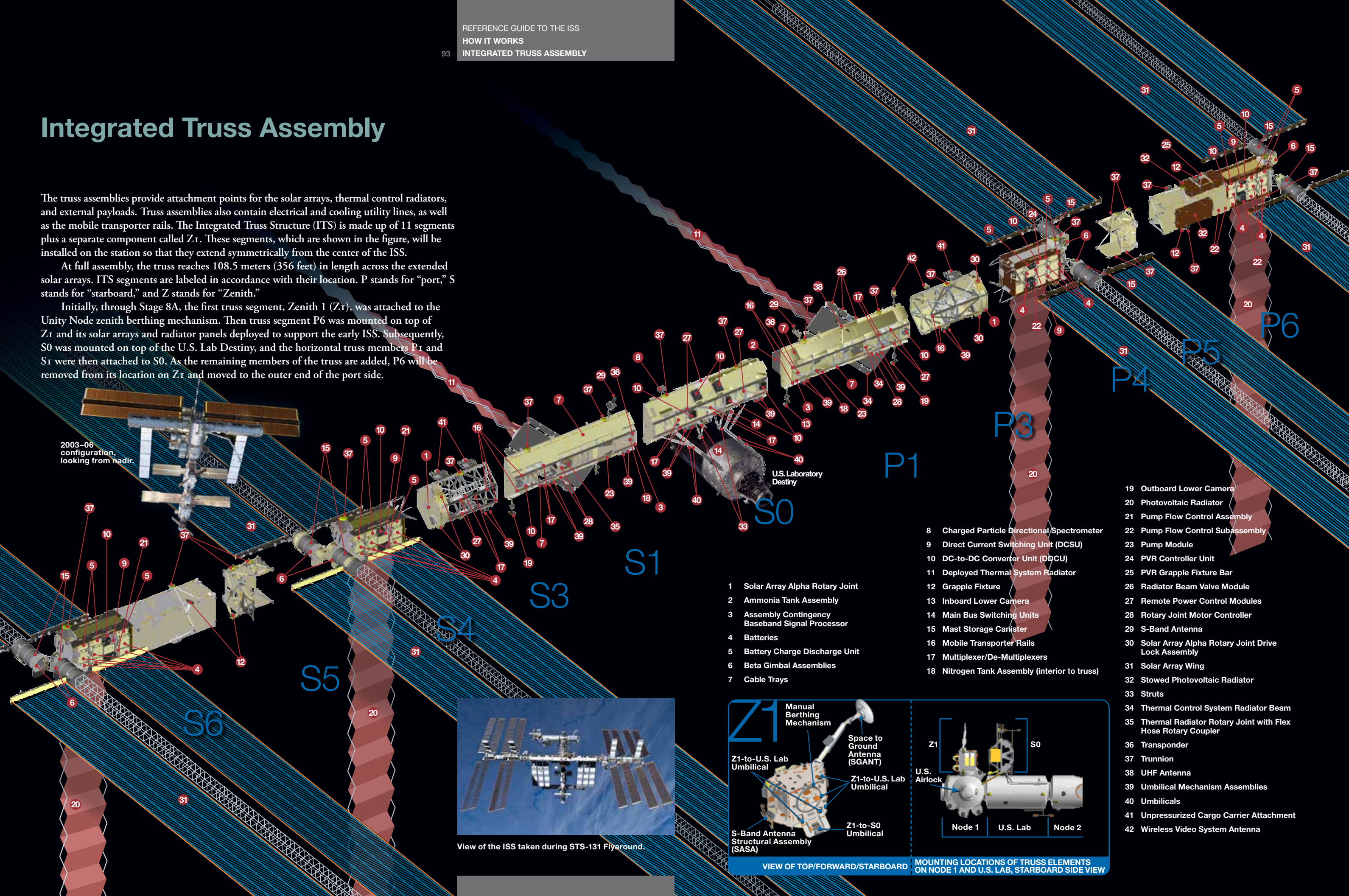
Integrated Truss Assembly

The truss assemblies provide attachment points for the solar arrays, thermal control radiators, and external payloads. Truss assemblies also contain electrical and cooling utility lines, as well as the mobile transporter rails. The Integrated Truss Structure (ITS) is made up of 11 segments plus a separate component called Z1. These segments, which are shown in the figure, will be installed on the station so that they extend symmetrically from the center of the ISS.

At full assembly, the truss reaches 108.5 meters (356 feet) in length across the extended solar arrays. ITS segments are labeled in accordance with their location. P stands for "port," S stands for "starboard," and Z stands for "Zenith."

Initially, through Stage 8A, the first truss segment, Zenith 1 (Z1), was attached to the Unity Node zenith berthing mechanism. Then truss segment P6 was mounted on top of Z1 and its solar arrays and radiator panels deployed to support the early ISS. Subsequently, S0 was mounted on top of the U.S. Lab Destiny, and the horizontal truss members P1 and S1 were then attached to S0. As the remaining members of the truss are added, P6 will be removed from its location on Z1 and moved to the outer end of the port side.

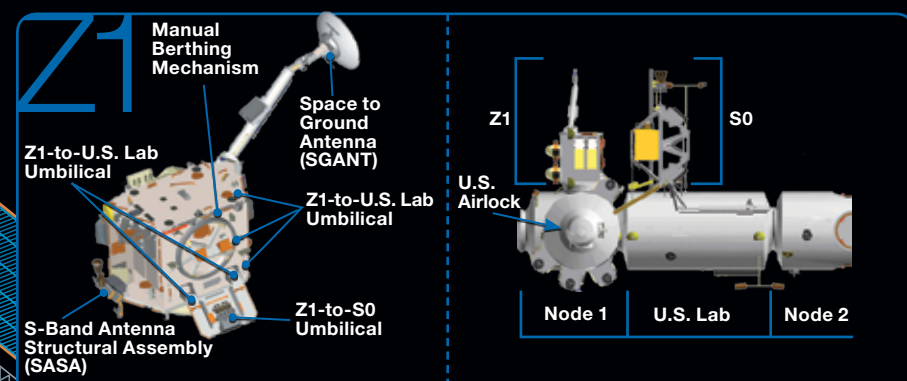
2003-06 configuration, looking from nadir.



- 1 Solar Array Alpha Rotary Joint
- 2 Ammonia Tank Assembly
- 3 Assembly Contingency Baseband Signal Processor
- 4 Batteries
- 5 Battery Charge Discharge Unit
- 6 Beta Gimbal Assemblies
- 7 Cable Trays
- 8 Charged Particle Directional Spectrometer
- 9 Direct Current Switching Unit (DCSU)
- 10 DC-to-DC Converter Unit (DDCU)
- 11 Deployed Thermal System Radiator
- 12 Grapple Fixture
- 13 Inboard Lower Camera
- 14 Main Bus Switching Units
- 15 Mast Storage Canister
- 16 Mobile Transporter Rails
- 17 Multiplexer/De-Multiplexers
- 18 Nitrogen Tank Assembly (interior to truss)
- 19 Outboard Lower Camera
- 20 Photovoltaic Radiator
- 21 Pump Flow Control Assembly
- 22 Pump Flow Control Subassembly
- 23 Pump Module
- 24 PVR Controller Unit
- 25 PVR Grapple Fixture Bar
- 26 Radiator Beam Valve Module
- 27 Remote Power Control Modules
- 28 Rotary Joint Motor Controller
- 29 S-Band Antenna
- 30 Solar Array Alpha Rotary Joint Drive Lock Assembly
- 31 Solar Array Wing
- 32 Stowed Photovoltaic Radiator
- 33 Struts
- 34 Thermal Control System Radiator Beam
- 35 Thermal Radiator Rotary Joint with Flex Hose Rotary Coupler
- 36 Transponder
- 37 Trunnion
- 38 UHF Antenna
- 39 Umbilical Mechanism Assemblies
- 40 Umbilicals
- 41 Unpressurized Cargo Carrier Attachment
- 42 Wireless Video System Antenna



View of the ISS taken during STS-131 Flyaround.



VIEW OF TOP/FORWARD/STARBOARD MOUNTING LOCATIONS OF TRUSS ELEMENTS ON NODE 1 AND U.S. LAB, STARBOARD SIDE VIEW

Propulsion



progress

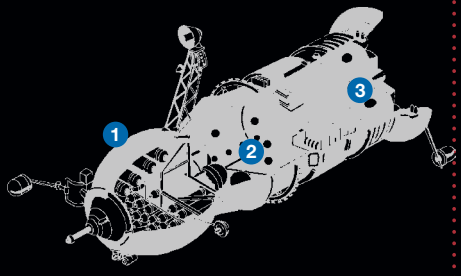
service module

fgb

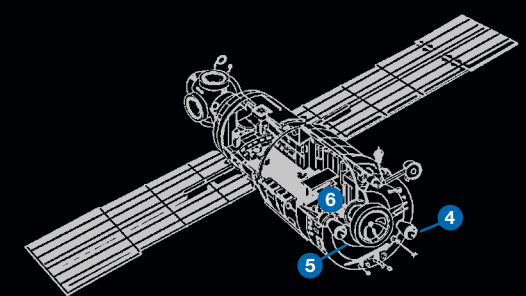
node/airlock

u.s. lab

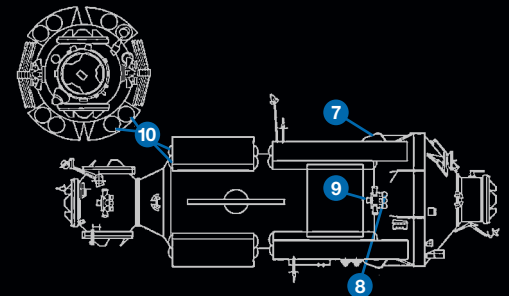
jem/columbus



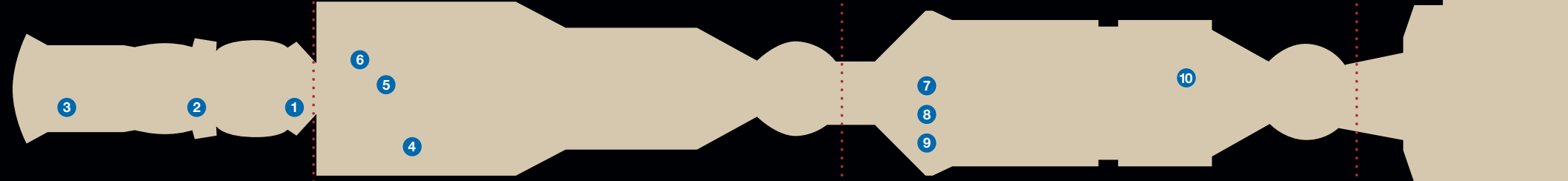
- 1 Progress Cargo Module
- 2 Propellant Resupply Tanks
- 3 Progress Propulsion System



- 4 Main Engines (2)
- 5 Attitude Control Engines (32)
- 6 Propellant Tanks (4)



- 7 Correction and Docking Engines (2)
- 8 Correction and Docking Engines (2)
- 9 Accurate Stabilization Engines (16)
- 10 Propellant Tanks (16)



Progress Rocket Engines

Progress is used for propellant resupply and for performing reboosts. For the latter, Progress is preferred over the Service Module. Progress uses four or eight attitude control engines, all firing in the direction for reboost.

Orbital Correction Engine:
1 axis, 300 kgf (661 lbf)

Attitude Control Engines:
28 multidirectional, 13.3 kgf (29.3 lbf)

Service Module Rocket Engines

Main Engines: 2,300 kgf (661 lbf), lifetime of 25,000 seconds; one or both main engines can be fired at a time; they are fed from the Service Module's propellant storage system

Attitude Control Engines: 32 multidirectional, 13.3 kgf (29.3 lbf); attitude control engines can accept propellant fed from the Service Module, the attached Progress, or the FGB propellant tanks

Service Module Propellant Storage
Two pairs of 200-L (52.8-gal) propellant tanks (two nitrogen tetroxide N_2O_4 and two unsymmetrical dimethyl hydrazine [UDMH]) provide a total of 860 kg (1,896 lb) of usable propellant. The propulsion system rocket engines use the hypergolic reaction of UDMH and N_2O_4 . The Module employs a pressurization system using N_2 to manage the flow of propellants to the engines.

FGB Rocket Engines

FGB engines are deactivated once the Service Module is in use.

Correction and Docking Engines:
2 axis, 417 kgf (919 lbf)

Docking and Stabilization Engines:
24 multidirectional, 40 kgf (88 lbf)

Accurate Stabilization Engines:
16 multidirectional, 1.3 kgf (2.86 lbf)

FGB Propellant Storage
There are two types of propellant tanks in the Russian propulsion system: bellows tanks (SM, FGB), able both to receive and to deliver propellant, and diaphragm tanks (Progress), able only to deliver fuel.

Sixteen tanks provide 5,760 kg (12,698 lb) of N_2O_4 and UDMH storage: eight long tanks, each holding 400 L (105.6 gal), and eight short tanks, each holding 330 L (87.17 gal).

The ISS orbits Earth at an altitude ranging from 370 to 460 kilometers (230 to 286 miles) and at a speed of 28,000 kilometers per hour (17,500 miles per hour). Due to atmospheric drag, the ISS is constantly slowed and must be re-boosted periodically to maintain its altitude. The ISS must be maneuvered to assist in rendezvous and docking of visiting vehicles and to avoid debris.

Thrusters located on the Service Module, as well as on the docked vehicles are used to perform these maneuvers.

The Service Module provides thirty-two 13.3-kilograms force (29.3-pounds force) attitude control engines. The engines are combined into two groups of 16 engines each, taking care of pitch, yaw, and roll control. Each Progress provides 24 engines similar to those on the Service Module. When a Progress is docked at the aft Service Module port, these engines can be used for pitch and yaw control. When the Progress is docked at the Russian Docking Module, the Progress engines can be used for roll control.

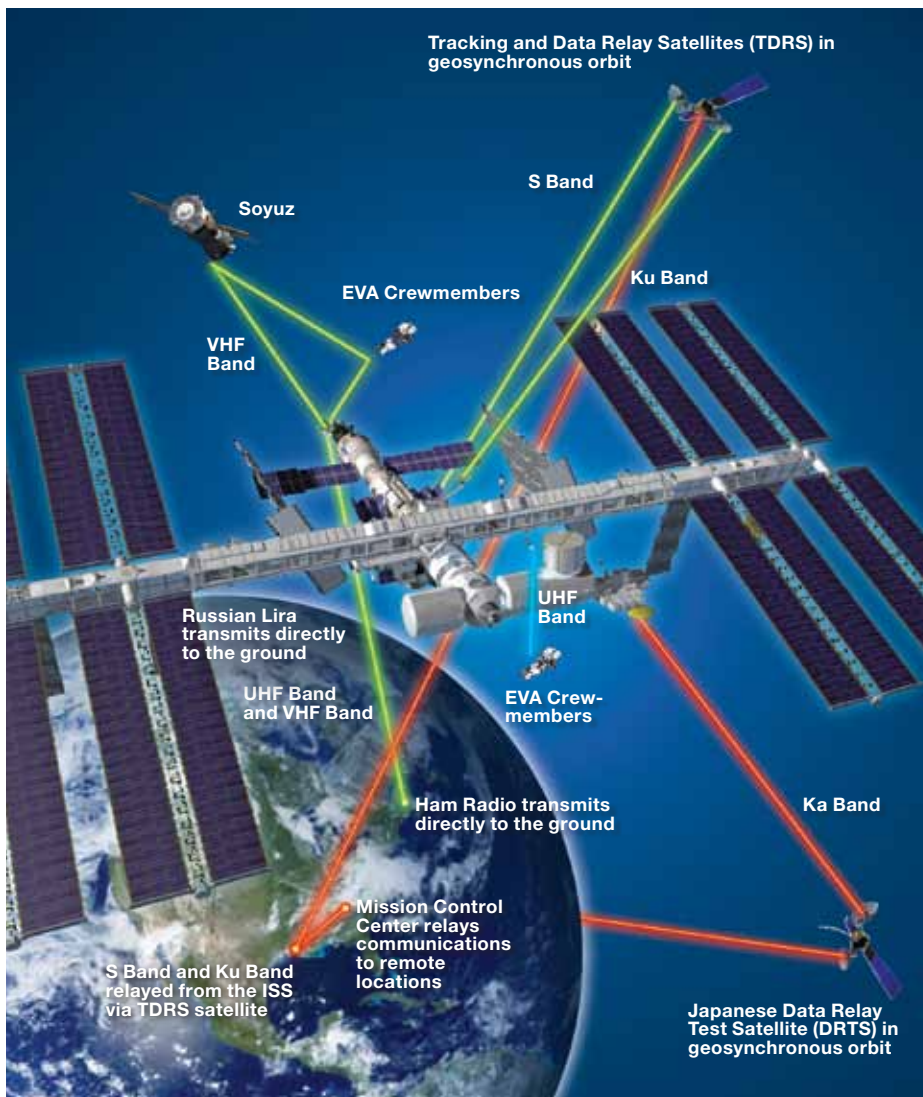
Besides being a resupply vehicle, the Progress provides a primary method for reboosting the ISS. Eight 13.3-kilograms force (29.3-pounds force) Progress engines can be used for reboosting. The Service Module engines can also be used for reboosting. The Progress can also be used to resupply propellants stored in the FGB that are used in the Service Module engines. The ESA ATV and JAXA HTV will also provide propulsion and reboost capability.

Communications

The radio and satellite communications network allows ISS crews to talk to the ground control centers and visiting vehicles. It also enables ground control to monitor and maintain ISS systems and operate payloads, and it permits flight controllers to send commands to those systems. The network routes payload data to the different control centers around the world.

The communications system provides the following:

- Two-way audio and video communication among crewmembers aboard the ISS, including crewmembers who participate in an extravehicular activity (EVA).
- Two-way audio, video, and file transfer communication between the ISS and flight control teams located in the Mission Control Center-Houston (MCC-H), other ground control centers, and payload scientists on the ground.
- Transmission of system and payload telemetry from the ISS to the MCC-H and the Payload Operations Center (POC).
- Distribution of ISS experiment data through the POC to payload scientists.
- Control of the ISS by flight controllers through commands sent via the MCC-H.



Ku band radio in U.S. Lab.



UHF antenna on the P1 Truss.



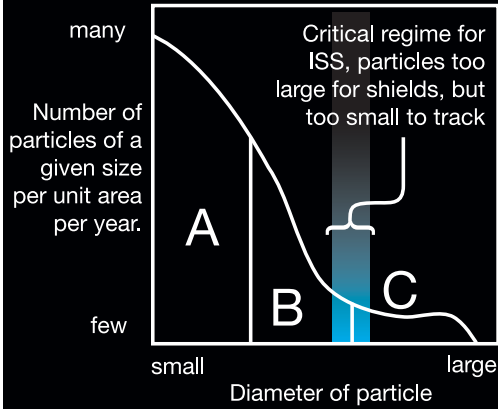
Ku band radio on exterior of ISS.



Yuri Onufrienko during communications pass.



Expedition 22 crewmembers performing a public affairs event in Kibo.



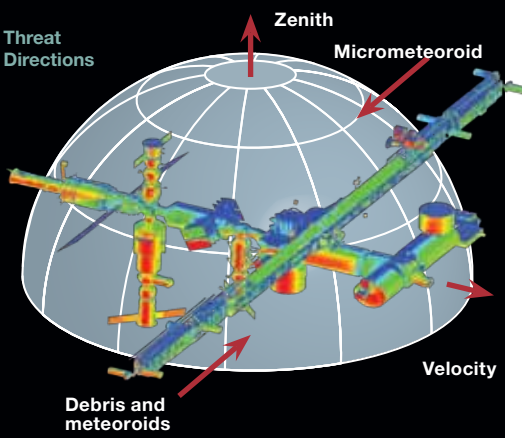
- A Pressure shell penetrations unlikely
- B Possible penetrations that can be mitigated with shields
- C Larger debris is tracked and ISS is maneuvered out of impact path



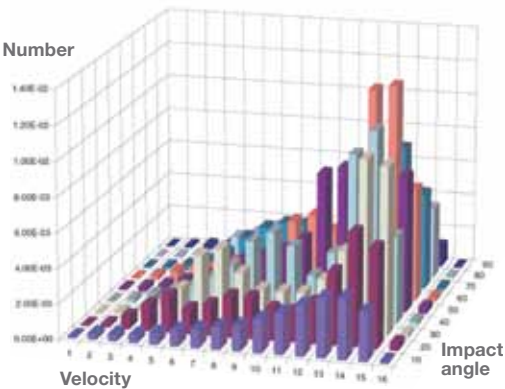
A 1.4-mm-diameter (inside) hole found in March 2001 in an ISS mini-pressurized logistics module outer bumper panel (no damage reported to pressure shell).

This 6-cm (2.4-in) x 3-cm (1.2-in) hole in the thermal blanket over the MMOD shield on the FGB module was found by crew in June 2007.

Micrometeorites may approach the ISS from any direction but are less likely from below, where Earth acts as a shield. Debris will typically approach ISS on a path roughly parallel with Earth's surface and from the side or front.



Risk computations based on exposure and shielding.



Micrometeoroid and Orbital Debris (MMOD) Protection

Spacecraft in low-Earth orbit are continually impacted by meteoroids and orbital debris. Most of the meteoroids and debris are small and cause little damage. A small fraction of the meteoroid and debris populations, however, are larger and can cause severe damage in a collision with a spacecraft.

The International Space Station (ISS) is the largest spacecraft ever built. With the completion of assembly, more than 11,000 m² (118, 400 ft²) of surface area is exposed to the space environment. Due to its large surface area, its long planned lifetime, and the potential for a catastrophic outcome of a collision, protecting the ISS from meteoroids and debris poses a unique challenge.

Many ISS elements are shielded from impacts. There are three primary shielding configurations:

- Whipple shield is a two layer shield consisting of an outer bumper, usually aluminum, spaced some distance from the module pressure shell wall; the bumper plate is intended to break up, melt, or vaporize a particle on impact.
- Stuffed Whipple shield consists of an outer bumper, an underlying blanket of Nextel ceramic cloth, and Kevlar fabric to further disrupt and disperse the impactor, spaced a distance from the module pressure shell.
- Multi-layer shields consist of multiple layers of either fabric and/or metallic panels protecting the critical item.

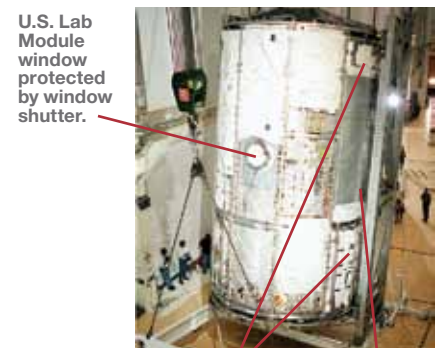
Other critical areas, such as electrical, data, and fluid lines on the truss and radiator panels, are toughened with additional protective layers to prevent loss from MMOD impacts.



U.S. Lab in orbit, above, Ken Bowersox uses camera at window with partially deployed shutter; to right, window shutter fully deployed; outer debris shields are visible.



U.S. Lab Module Prior to installation of most micrometeoroid and orbital debris outer shields.



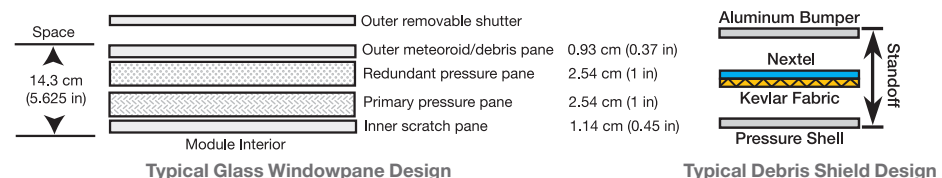
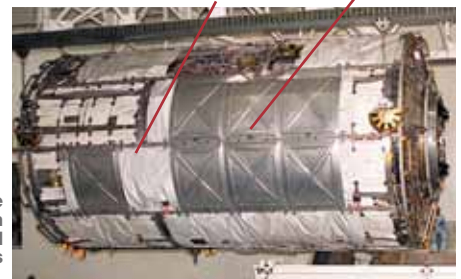
U.S. Lab Module window protected by window shutter.

Intermediate Debris Shield, Nextel, and Kevlar Blankets. Outer Debris Shield, Aluminum



Deployed shutters for Cupola windows.

U.S. Lab Module during installation of micrometeoroid and orbital debris shielding.



how it's built

The ISS design evolved over a decade. Like a Lego set, each piece of the ISS was launched and assembled in space, using complex robotics systems and humans in spacesuits connecting fluid lines and electrical wires.

The ISS components were built in various countries around the world, with each piece performing once connected in space, a testament to the teamwork and cultural coordination.



ISS Expanded View

ISS Assembly Complete

Length	74 m (243 ft)
Width	110 m (361 ft)
Mass	419,600 kg (925,000 lb)
Pressurized volume	935 m ³ (33,023 ft ³)
Array surface area	2,500 m ² (27,000 ft ²)
Power	110 kW



Principal Stages in Construction







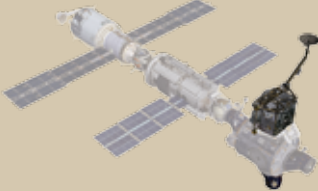

The ISS, at assembly complete in 2010, is to be the largest humanmade object ever to orbit Earth. The ISS is to have a pressurized volume of 860 m³ (30,385 ft³) and a mass of 399,380 kg (880,483 lb) including Soyuz vehicles. Its solar arrays will cover an area of 2,247 m² (24,187 ft²) and can generate 735,840 kW-hours of electrical power per year. The ISS will have a structure that measures 109 m (358 ft) (across arrays) by 51 m (168 ft) (module length from the forward end of PMA2 to the aft end of the SM), an orbital altitude of 370–460 km (200–250 nmi), an orbital inclination of 51.6°, and a crew of six.

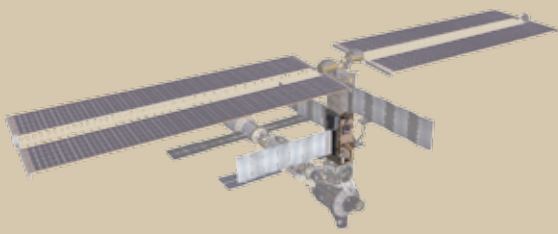

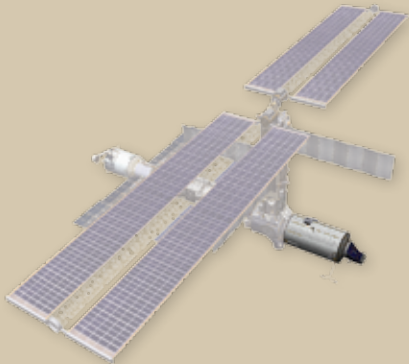

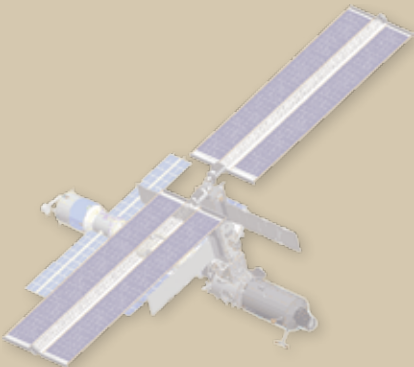

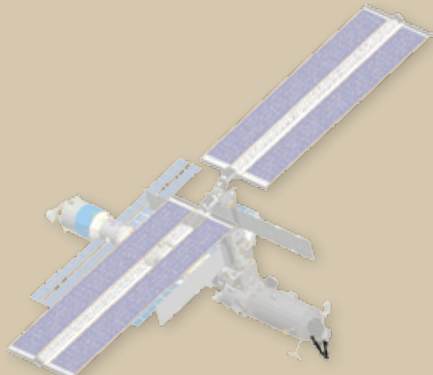

Building the ISS requires 36 Space Shuttle assembly flights and 5 Russian launches. Currently, logistics and resupply are provided through a number of vehicles including the Space Shuttle, Russian Progress and Soyuz, Japanese H-II Transfer Vehicle (HTV), and European Automated Transfer Vehicle (ATV).





Future logistics/resupply missions will also be provided by the U.S. Crew Exploration Vehicle (CEV) and commercial systems.



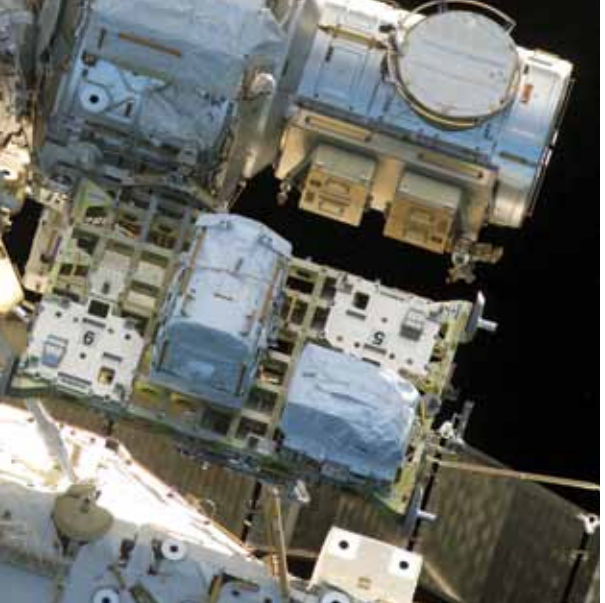
ISS stage number/letter conventions:

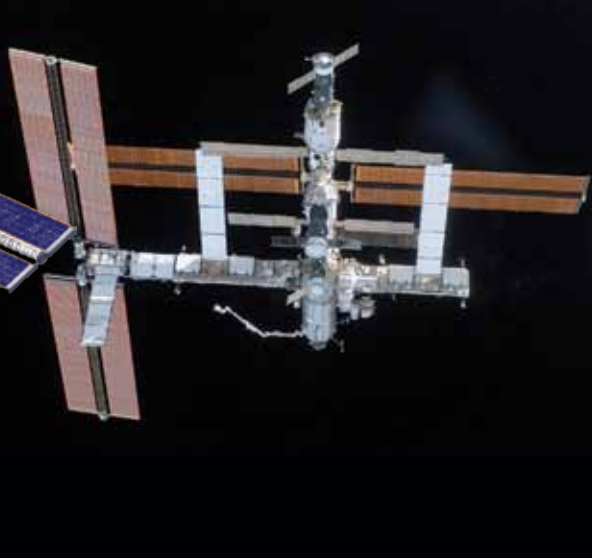
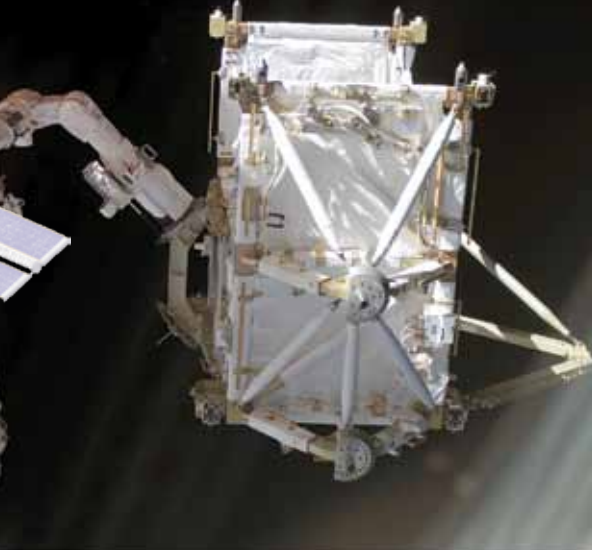

- A=U.S. Assembly
- E=European Assembly
- J=Japanese Assembly
- LF=Logistics
- R=Russian Assembly
- UF=Utilization
- ULF=Utilization/Logistics




Stage/ Date	Element Added	Launch Vehicle	ISS Picture
1A/R November 1998	 Functional Cargo Block (FCB)	Proton	
2A December 1998	 Node 1, Pressurized Mating Adapter (PMA) 1, 2	Space Shuttle STS-88	
1R July 2000	 Service Module (SM)	Proton	
3A October 2000	 Zenith 1 (Z1) Truss, PMA 3	Space Shuttle STS-92	

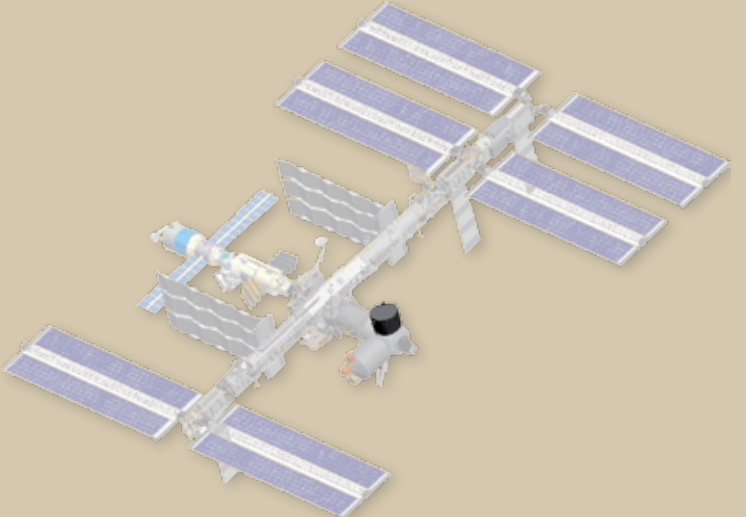
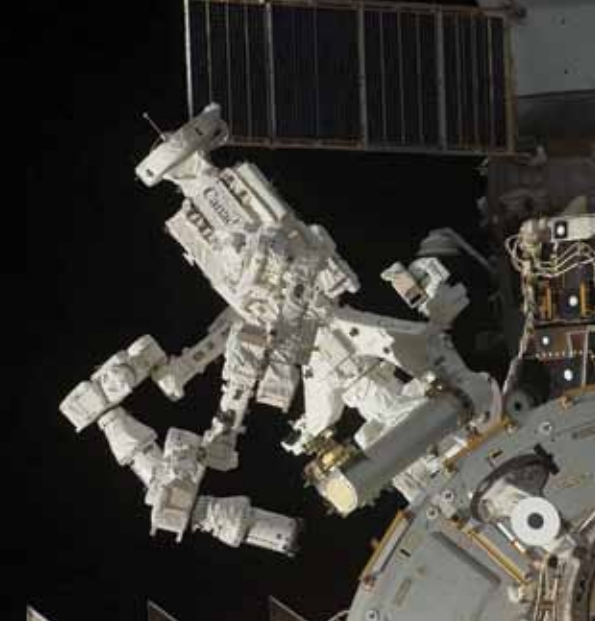
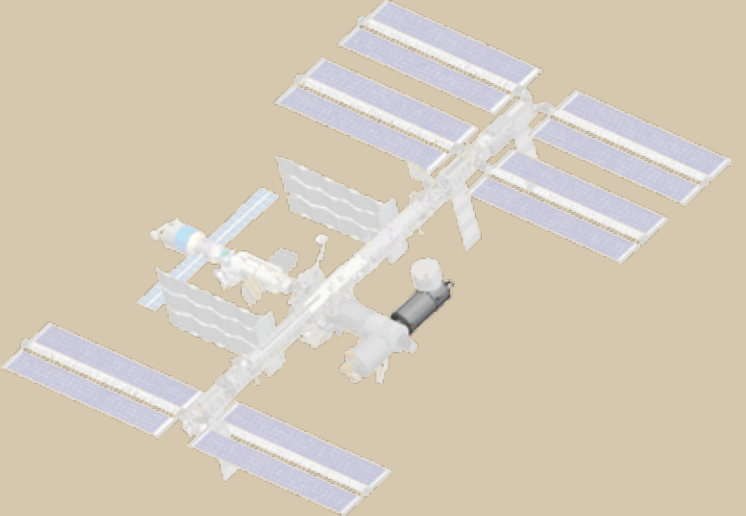

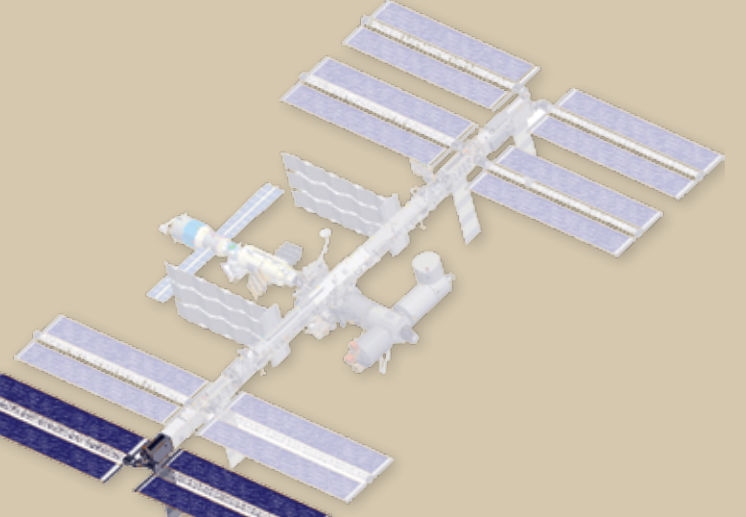
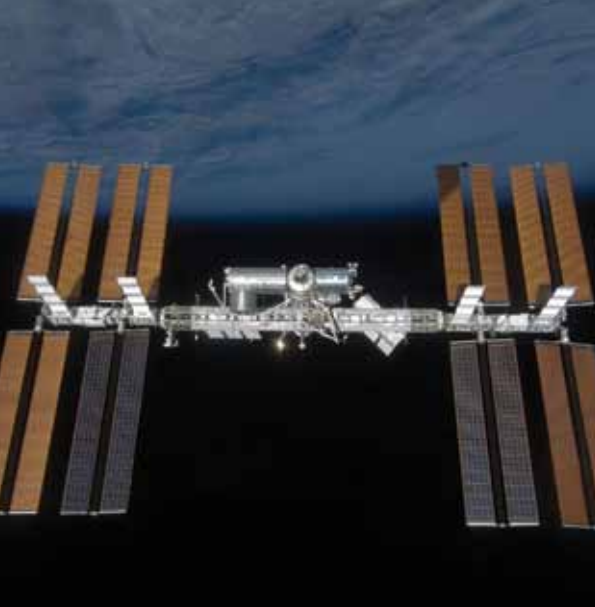
Stage/ Date	Element Added	Launch Vehicle	ISS Picture
4A December 2000	 <p>Port 6 (P6) Truss</p>	Space Shuttle STS-97	
5A February 2001	 <p>U.S. Laboratory (Lab)</p>	Space Shuttle STS-98	
5A.1 March 2001	 <p>External Stowage Platform (ESP) 1</p>	Space Shuttle STS-98	
6A April 2001	 <p>Space Station Remote Manipulator System (SSRMS)</p>	Space Shuttle STS-100	

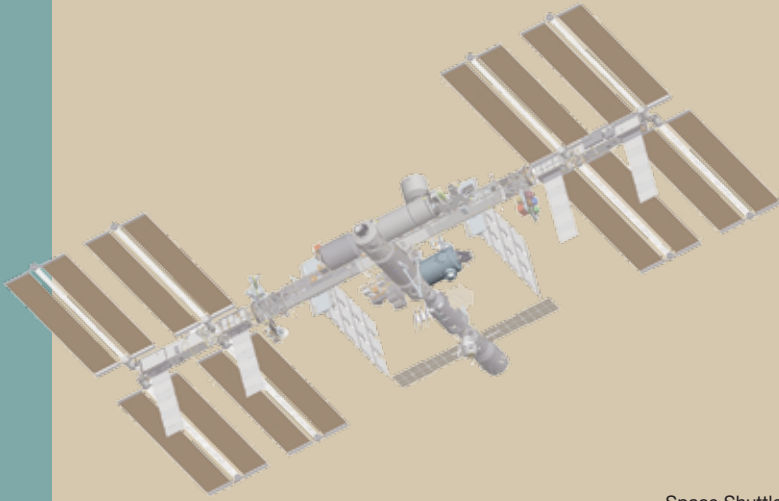

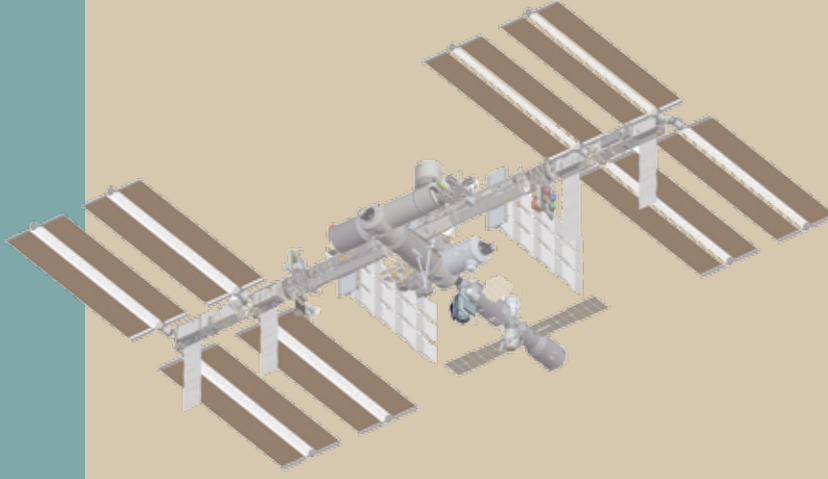

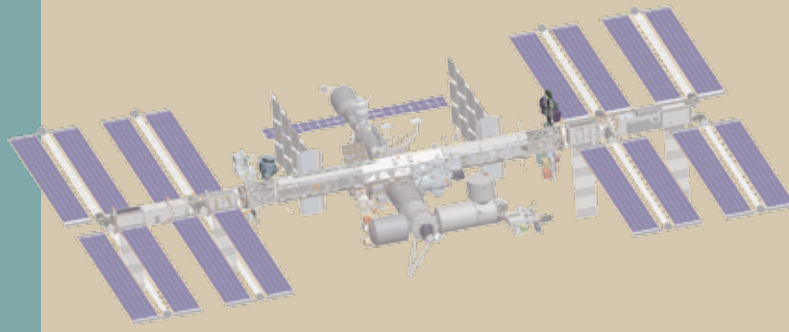

Stage/ Date	Element Added	Launch Vehicle	ISS Picture
7A July 2001	U.S. Airlock	Space Shuttle STS-104	
4R September 2001	Russian Docking Compartment (DC) and Airlock	Soyuz	
8A April 2002	Starboard Zero (S0) Truss and Mobile Transporter (MT)	Space Shuttle STS-110	
UF-2 June 2002	Mobile Base System	Space Shuttle STS-111	

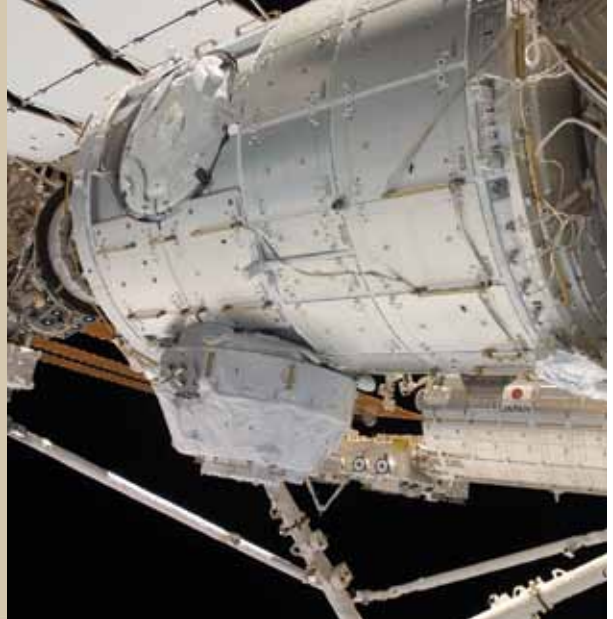
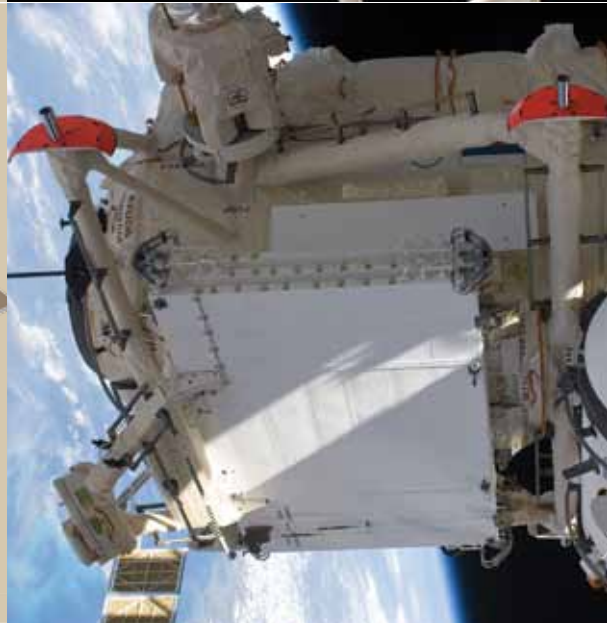

Stage/ Date	Element Added	Launch Vehicle	ISS Picture
9A October 2002	S1 Truss and Crew Equipment Translation Aid (CETA) Cart	Space Shuttle STS-112	
11A November 2002	P1 Truss and CETA Cart	Space Shuttle STS-113	
LF1 July 2005	ESP-2	Space Shuttle STS-114	

Stage/ Date	Element Added	Launch Vehicle	ISS Picture
12A September 2006	P3/P4 Truss	Space Shuttle STS-115	
12A.1 December 2006	P5 Truss, retracting P6 arrays	Space Shuttle STS-116	
13A June 2007	S3/S4 Truss	Space Shuttle STS-117	

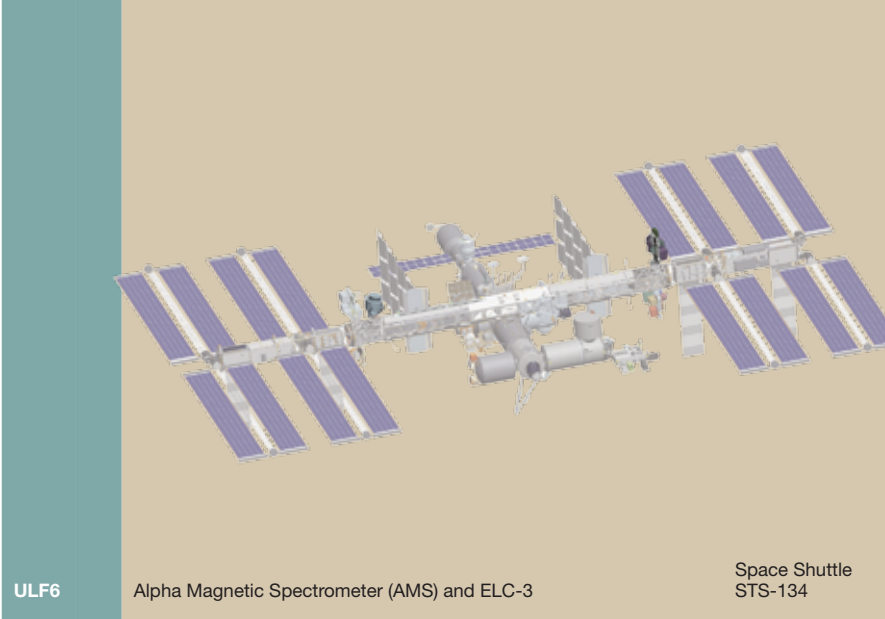
Stage/ Date	Element Added	Launch Vehicle	ISS Picture
13A.1 August 2007	S5 Truss and ESP-3	Space Shuttle STS-118	
10A October 2007	Node 2, P6 relocated	Space Shuttle STS-120	
1E February 2008	ESA Columbus Module	Space Shuttle STS-122	

Stage/ Date	Element Added	Launch Vehicle	ISS Picture
1J/A March 2008	 <p>Japanese Experiment Module Experiment Logistics Module Pressurized Section (JEM-ELM-PS) and Canadian Special Purpose Dexterous Manipulator (Dextre)</p>	Space Shuttle STS-123	
1J June 2008	 <p>JEM Pressurized Module (PM)</p>	Space Shuttle STS-124	
15A March 2009	 <p>S6 Truss</p>	Space Shuttle STS-119	

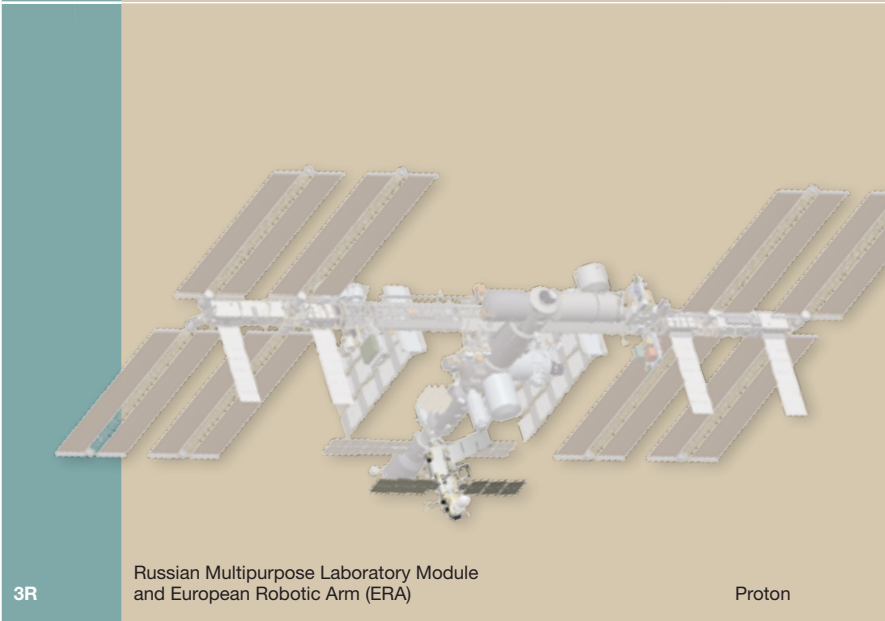
Stage/ Date	Element Added	Launch Vehicle	ISS Picture
2J/A July 2009	 <p>JEM Exposed Facility (JEM-EF)</p>	Space Shuttle STS-127	
5R November 2009	 <p>Russian Mini-Research Module 2</p>	Soyuz	
ULF3 November 2009	 <p>ExPRESS Logistics Carriers (ELC) 1, 2</p>	Space Shuttle STS-129	

Stage/ Date	Element Added	Launch Vehicle	ISS Picture
20A February 2010	Node 3 and Cupola	Space Shuttle STS-130	
ULF4 May 2010	Russian Mini-Research Module 1 (MRM-1)	Space Shuttle STS-132	
ULF5	Permanent Multipurpose Module (PMM) and ELC-4	Space Shuttle STS-133	

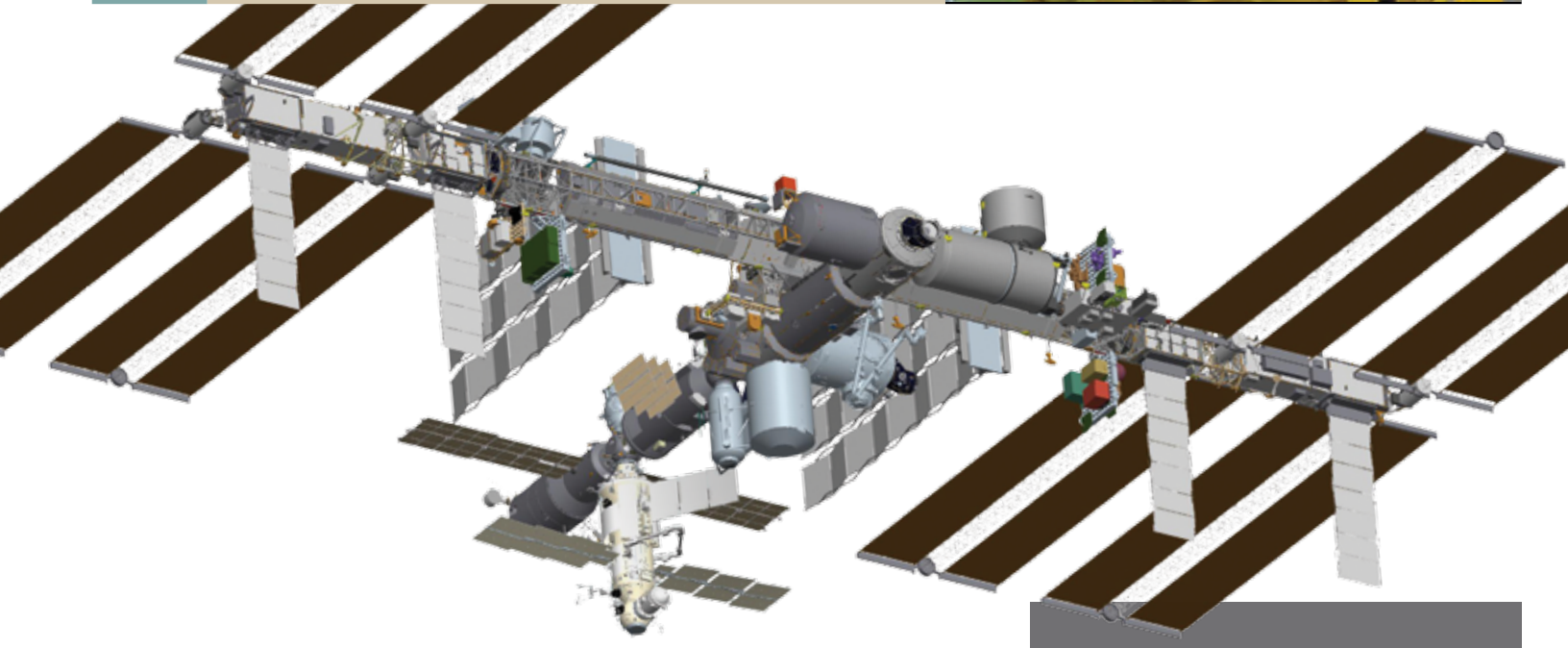
Stage/ Date	Element Added	Launch Vehicle	ISS Picture
----------------	---------------	----------------	-------------




ULF6 Alpha Magnetic Spectrometer (AMS) and ELC-3 Space Shuttle STS-134



3R Russian Multipurpose Laboratory Module and European Robotic Arm (ERA) Proton



















High-performing personnel are key to International Space Station (ISS) mission success. International crewmembers and ground controllers who support assembly, logistics, and long-duration missions have highly specialized skills and training. They also utilize procedures and tools developed especially for the ISS.

The experience gained from the ISS program has improved the interaction between the flight crews and ground-team members and has made missions safer and more effective. Moreover, working with teams from many countries and cultures on the ground and in space has provided (and continues to provide) innovative solutions to critical operational challenges.

missions



ISS Expeditions and Crews

Expedition	Expedition patch	Crew photo	Crew	Expedition Start/End/Duration
1			William Shepherd, U.S. Yuri Gidzenko, Russia (Roscosmos) Sergei Krikalev, Russia (Roscosmos)	Start on November 2, 2001 End on March 18, 2001 136 days on ISS
2			Yuri Usachev, Russia (Roscosmos) Jim Voss, U.S. Susan Helms, U.S.	Start March 10, 2001 End August 20, 2001 163 days on ISS
3			Frank Culbertson, U.S. Vladimir Dezhurov, Russia (Roscosmos) Mikhail Tyurin, Russia (Roscosmos)	Begin August 12, 2001 End December 15, 2001 125 days on ISS
4			Yury Onufrienko, Russia (Roscosmos) Carl Walz, U.S. Daniel Bursch, U.S.	Start December 7, 2001 End June 15, 2001 190 days on ISS
5			Valery Korzun, Russia (Roscosmos) Sergei Treshev, Russia (Roscosmos) Peggy Whitson, U.S.	Start June 7, 2002 December 2, 2002 178 days on ISS
6			Kenneth Bowersox, U.S. Nikolai Budarin, Russia (Roscosmos) Donald Pettit, U.S.	Start November 25, 2002 End May 3, 2003 159 days on ISS

Expedition	Expedition Patch	Crew Photo	Crew	Launch, Return, Duration
7			<p>Yuri Malenchenko, Russia (Roscosmos) Edward Lu, U.S.</p>	<p>Start April 28, 2003 End October 27, 2003 183 days on ISS</p>
8			<p>Michael Foale, U.S. Alexander Kaleri, Russia (Roscosmos)</p>	<p>Start October 20, 2003 End April 29, 2004 193 days on ISS</p>
9			<p>Gennady Padalka, Russia (Roscosmos) E. Michael Fincke, U.S.</p>	<p>Start April 21, 2004 End October 23, 2004 186 days on ISS</p>
10			<p>Leroy Chiao, U.S. Salizhan Sharipov, Russia (Roscosmos)</p>	<p>Start October 16, 2004 End April 24, 2005 191 days on ISS</p>
11			<p>Sergei Krikalev, Russia (Roscosmos) John Phillips, U.S.</p>	<p>Start April 17, 2005 End October 10, 2005 177 days on ISS</p>
12			<p>William McArthur, U.S. Valery Tokarev, Russia (Roscosmos)</p>	<p>Start October 3, 2005 End April 8, 2006 188 days on ISS</p>
13			<p>Pavel Vinogradov, Russia (Roscosmos) Jeffrey Williams, U.S. Thomas Reiter, Germany (ESA)</p>	<p>Start April 1, 2006 End September 28, 2006 181 days on ISS</p>

Expedition	Expedition Patch	Crew Photo	Crew	Launch, Return, Duration
14			Michael Lopez-Alegria, U.S. Mikhail Tyurin, Russia (Roscosmos) Thomas Reiter, Germany (ESA) Sunita Williams, U.S.	Start September 18, 2006 End April 21, 2007 205 days on ISS
15			Fyodoro Yurchikhin, Russia (Roscosmos) Oleg Kotov, Russia (Roscosmos) Sunita Williams, U.S. Clayton Anderson, U.S.	Start April 7, 2007 End October 21, 2007 197 days on ISS
16			Peggy Whitson, U.S. Yuri Malenchenko, Russia (Roscosmos) Clayton Anderson, U.S. Daniel Tani, U.S. Léopold Eyharts, France (ESA) Garrett Reisman, U.S.	Start October 10, 2007 End April 19, 2008 192 days on ISS
17			Sergey Vokov, Russia (Roscosmos) Oleg Kononenko, Russia (Roscosmos) Garrett Reisman, U.S. Gregory Chamitoff, U.S.	Start April 8, 2008 End October, 23 2008 198 days on ISS
18			Michael Finke, U.S. Yuri Lonchakov, Russia (Roscosmos) Gregory Chamitoff, U.S. Sandra Magnus, U.S. Kochi Wakata, Japan (JAXA)	Start October 12, 2008 End April 8, 2009 178 days on ISS
19			Gennady Padalka, Russia (Roscosmos) Michael Barratt, U.S. Kochi Wakata, Japan (JAXA)	Start April 8, 2009 End May 29, 2009 62 days on ISS
20			Gennady Padalka, Russia (Roscosmos) Michael Barratt, U.S. Kochi Wakata, Japan (JAXA) Timothy Kopra, U.S. Nicole Stott, U.S. Frank De Winne, Belgium (ESA) Roman Romanenko, Russia (Roscosmos) Robert Thirsk, Canada (CSA)	Start May 29, 2009 End October 11, 2009 135 days on ISS

















Expedition	Expedition Patch	Crew Photo	Crew	Launch, Return, Duration
21			<p>Frank De Winne, Belgium (ESA) Roman Romanenko, Russia (Roscosmos) Robert Thirsk, Canada (CSA) Jeffrey Williams, U.S. Maksim Surayev, Russia (Roscosmos) Nicole Stott, U.S.</p>	<p>Start October 11, 2009 End December 1, 2009 51 days on ISS</p>
22			<p>Jeffrey Williams, U.S. Maksim Surayev, Russia (Roscosmos) Oleg Kotov, Russia (Roscosmos) Soichi Noguchi, Japan (JAXA) Timothy Creamer, U.S.</p>	<p>Start December 1, 2009 End March 18, 2010 107 days on ISS</p>
23			<p>Oleg Kotov, Russia (Roscosmos) Soichi Noguchi, Japan (JAXA) Timothy Creamer, U.S. Aleksandr Skvortsov, Russia (Roscosmos) Mikhail Korniyenko, Russia (Roscosmos) Tracy Caldwell Dyson, U.S.</p>	<p>Start March 18, 2010 End June 2, 2010 76 days on ISS</p>
24			<p>Aleksandr Skvortsov, Russia (Roscosmos) Mikhail Korniyenko, Russia (Roscosmos) Tracy Caldwell Dyson, U.S. Fyodor Yurchikhin, Russia (Roscosmos) Shannon Walker, U.S. Douglas Wheelock, U.S.</p>	<p>Start June 2, 2010</p>



STS Missions and Crews





Space Shuttle Missions to the ISS

Flight Numbers	Mission Patch	Crew Photo	Launch Package Patch	Crew	Launch, Return, Duration
<p>STS 88 Space Shuttle <i>Endeavour</i> ISS flight 2A</p>				<p>Robert Cabana, U.S. Nancy Currie, U.S. Sergei Krikalev, Russia (Roscosmos) James Newman, U.S. Jerry Ross, U.S. Frederick Sturckow, U.S.</p>	<p>Launched December 4, 1998 Returned December 15, 1998 12 days</p>
<p>STS 96 Space Shuttle <i>Discovery</i> ISS flight 2A.1</p>				<p>Kent Rominger, U.S. Daniel Barry, U.S. Rick Husband, U.S. Tamara Jernigan, U.S. Ellen Ochoa, U.S. Julie Payette, Canada (CSA) Valery Tokarev, Russia (Roscosmos)</p>	<p>Launched May 27, 1999 Returned June 6, 1999 10 days</p>
<p>STS 101 Space Shuttle <i>Atlantis</i> ISS flight 2A.2a</p>				<p>James Halsell, U.S. Susan Helms, U.S. Scott Horowitz, U.S. Yury Usachev, Russia (Roscosmos) James Voss, U.S. Mary Weber, U.S. Jeffrey Williams, U.S.</p>	<p>Launched May 19, 2000 Returned May 29, 2000 10 days</p>
<p>STS 106 Space Shuttle <i>Atlantis</i> ISS flight 2A.2b</p>				<p>Terrence Wilcutt, U.S. Scott Altman, U.S. Daniel Burbank, U.S. Edward Lu, U.S. Yuri Malenchenko, Russia (Roscosmos) Richard Mastracchio, U.S. Boris Morukov, Russia (Roscosmos)</p>	<p>Launched September 8, 2000 Returned September 19, 2000 12 days</p>
<p>STS 92 Space Shuttle <i>Discovery</i> ISS flight 3A</p>				<p>Leroy Chiao, U.S. Brian Duffy, U.S. Michael Lopez-Alegria, U.S. William McArthur, U.S. Pamela Melroy, U.S. Koichi Wakata, Japan (NASDA) Peter Wisoff, U.S.</p>	<p>Launched October 11, 2000 Returned October 24, 2000 13 days</p>
<p>STS 97 Space Shuttle <i>Endeavour</i> ISS flight 4A</p>				<p>Michael Bloomfield, U.S. Marc Garneau, Canada (CSA) Brent Jett, U.S. Carlos Noriega, U.S. Joseph Tanner, U.S.</p>	<p>Launched November 30, 2000 Landed December 11, 2000 11 days</p>

Flight Numbers	Mission Patch	Crew Photo	Launch Package Patch	Crew	Launch, Return, Duration
<p>STS 98 Space Shuttle <i>Atlantis</i> ISS flight 5A</p>				<p>Kenneth Cockrell, U.S. Robert Curbeam, U.S. Marsha Ivins, U.S. Thomas Jones, U.S. Mark Polansky, U.S.</p>	<p>Launched February 7, 2001 Returned February 20, 2001 13 days</p>
<p>STS 102 Space Shuttle <i>Discovery</i> ISS flight 5A.1</p>				<p>James Wetherbee, U.S. James Kelly, U.S. Paul Richards, U.S. Andrew Thomas, U.S. Yuri Usachev, Russia (Roscosmos), up James Voss, U.S., up Susan Helms, U.S., up William Shepherd, U.S., down Yuri Gidzenko, Russia (Roscosmos), down Sergei Krikalev, Russia (Roscosmos), down</p>	<p>Launched March 8, 2001 Returned March 21, 2001 13 days</p>
<p>STS 100 Space Shuttle <i>Atlantis</i> ISS flight 6A</p>				<p>Jeffrey Ashby, U.S. Umberto Guidoni, Italy (ESA) Chris Hadfield, Canada (CSA) Scott Parazynski, U.S. John Phillips, U.S. Kent Rominger, U.S. Yuri Lonchakov, Russia (Roscosmos)</p>	<p>Launched April 19, 2001 Returned May 1, 2001 12 days</p>
<p>STS 104 Space Shuttle <i>Atlantis</i> ISS flight 7A</p>				<p>Michael Gernhardt, U.S. Charles Hobaugh, U.S. Janet Kavandi, U.S. Steven Lindsey, U.S. James Reilly, U.S.</p>	<p>Launched July 12, 2001 Returned July 24, 2001 13 days</p>
<p>STS 105 Space Shuttle <i>Discovery</i> ISS flight 7A.1</p>				<p>Daniel Barry, U.S. Patrick Forrester, U.S. Scott Horowitz, U.S. Frederick Sturckow, U.S. Frank Culbertson, U.S., up* Vladimir Dezhurov, Russia (Roscosmos), up* Mikhail Turin, Russia (Roscosmos), up* Yuri Usachev, Russia (Roscosmos), down* James Voss, U.S., down* Susan Helms, U.S., down*</p>	<p>Launched August 10, 2001 Returned August 22, 2001 12 days</p>
<p>STS 108 Space Shuttle <i>Endeavour</i> ISS flight UF-1</p>				<p>Daniel Tani, U.S. Linda Godwin, U.S. Dominic Gorie, U.S. Mark Kelly, U.S. Daniel Bursch, U.S., up* Yuri Onufrienko, Russia (Roscosmos), up Carl Walz, U.S., up Frank Culbertson, U.S., down Vladimir Dezhurov, Russia (Roscosmos), down Mikhail Turin, Russia (Roscosmos), down</p>	<p>Launched December 5, 2001 Returned December 17, 2001 12 days</p>













Flight Numbers	Mission Patch	Crew Photo	Launch Package Patch	Crew	Launch, Return, Duration
<p>STS 110 Space Shuttle <i>Atlantis</i> ISS flight 8A</p>				<p>Michael Bloomfield, U.S. Stephen Frick, U.S. Lee Morin, U.S. Ellen Ochoa, U.S. Jerry Ross, U.S. Steven Smith, U.S. Rex Walheim, U.S.</p>	<p>Launched April 8, 2002 Returned April 19, 2002 11 days</p>
<p>STS 111 Space Shuttle <i>Endeavour</i> ISS flight 5A.1</p>				<p>Franklin Chang-Diaz, U.S. Kenneth Cockrell, U.S. Paul Lockhart, U.S. Philippe Perrin, France (CNES) Valery Korzun, Russia (Roscosmos), up Sergei Treschev, Russia (Roscosmos), up Peggy Whitson, U.S., up Daniel Bursch, U.S., down Yuri Onufrienko, Russia (Roscosmos), down Carl Walz, U.S., down</p>	<p>Launched June 5, 2002 Returned June 19, 2002 14 days</p>
<p>STS 112 Space Shuttle <i>Atlantis</i> ISS flight 9A</p>				<p>Jeffrey Ashby, U.S. Umberto Guidoni, Italy (ESA) Chris Hadfield, Canada (CSA) Scott Parazynski, U.S. John Phillips, U.S. Kent Rominger, U.S. Yuri Lonchakov, Russia (Roscosmos)</p>	<p>Launched October 7, 2002 Returned October 18, 2002 11 days</p>
<p>STS 113 Space Shuttle <i>Endeavour</i> ISS flight 11A</p>				<p>John Herrington, U.S. Paul Lockhart, U.S. Michael Lopez-Alegria, U.S. James Wetherbee, U.S. Kenneth Bowersox, U.S., up Nikolai Budarin, Russia (Roscosmos), up Donald Pettit, U.S., up Valery Korzun, Russia (Roscosmos), down Sergei Treschev, Russia (Roscosmos), down Peggy Whitson, U.S., down</p>	<p>Launched November 23, 2002 Returned December 7, 2002 14 days</p>
<p>STS 114 Space Shuttle <i>Discovery</i> ISS flight LF1</p>				<p>Eileen Collins, U.S. James Kelly, U.S. Soichi Noguchi, Japan (JAXA) Stephen Robinson, U.S. Andrew Thomas, U.S. Wendy Lawrence, U.S. Charles Camarda, U.S.</p>	<p>Launched July 26, 2005 Returned August 9, 2005 14 days</p>
<p>STS 121 Space Shuttle <i>Discovery</i> ISS flight ULF1.1</p>				<p>Daniel Tani, U.S. Linda Godwin, U.S. Dominic Gorie, U.S. Mark Kelly, U.S. Daniel Bursch, U.S., up Yuri Onufrienko, Russia (Roscosmos), up Carl Walz, U.S., up Frank Culbertson, U.S., down Vladimir Dezhurov, Russia (Roscosmos), down Mikhail Turin, Russia (Roscosmos), down</p>	<p>Launched July 4, 2006 Returned July 17, 2006 13 days</p>



Flight Numbers	Mission Patch	Crew Photo	Launch Package Patch	Crew	Launch, Return, Duration
<p>STS 115 Space Shuttle <i>Discovery</i> ISS flight 12A</p>				<p>Brent Jett, U.S. Christopher Ferguson, U.S. Heidemarie Stefanyshyn-Piper, U.S. Joseph Tanner, U.S. Daniel Burbank, U.S. Steven MacLean, Canada (CSA)</p>	<p>Launched September 9, 2006 Returned September 21, 2006 12 days</p>
<p>STS 116 Space Shuttle <i>Discovery</i> ISS flight 12A.1</p>				<p>Mark L. Polansky, U.S. William A. Oefelein, U.S. Nicholas J.M. Patrick, U.S. Robert L. Curbeam, U.S. Christer Fuglesang, Sweden (ESA) Joan E. Higginbotham, U.S. Sunita L. Williams, U.S.</p>	<p>Launched December 10, 2006 Returned December 22, 2006 13 days</p>
<p>STS 117 Space Shuttle <i>Atlantis</i> ISS flight 13A</p>				<p>Frederick W. Sturckow, U.S. Lee J. Archambault, U.S. Patrick G. Forrester, U.S. Steven R. Swanson, U.S. John D. Olivas, U.S. James F. Reilly, U.S. Clayton C. Anderson, U.S.</p>	<p>Launched June 08, 2007 Returned June 22, 2007 14 days</p>
<p>STS 118 Space Shuttle <i>Atlantis</i> ISS flight 13A.1</p>				<p>Scott J. Kelly, U.S. Charles O. Hobbaugh, U.S. Tracy E. Caldwell Dyson, U.S. Richard A. Mastracchio, U.S. Dafydd R. Williams, Canada (CSA) Barbara R. Morgan, U.S. Benjamin A. Drew, U.S.</p>	<p>Launched August 8, 2007 Returned August 21, 2007 13 days</p>
<p>STS 120 Space Shuttle <i>Discovery</i> ISS flight 10A</p>				<p>Pamela A. Melroy, U.S. George D. Zamka, U.S. Scott E. Parazynski, U.S. Stephanie D. Wilson, U.S. Douglas H. Wheelock, U.S. Paolo Nespoli, Italy (ESA) Daniel M. Tani, U.S.</p>	<p>Launched October 23, 2007 Returned November 7, 2007 15 days</p>
<p>STS 122 Space Shuttle <i>Endeavour</i> ISS flight 1E</p>				<p>Stephen N. Frick, U.S. Alan G. Poindexter, U.S. Leland D. Melvin, U.S. Rex J. Walheim, U.S. Hans Schlegel, Germany (ESA) Stanley G. Love, U.S. Léopold Eyharts, France (ESA)</p>	<p>Launched February 7, 2008 Returned February 20, 2008</p>

Flight Numbers	Mission Patch	Crew Photo	Launch Package Patch	Crew	Launch, Return, Duration
<p>STS 123 Space Shuttle <i>Atlantis</i> ISS flight 1J/A</p>				<p>Dominic L. Pudwill Gorie, U.S. Gregory H. Johnson, U.S. Robert L. Behnken, U.S. Michael J. Foreman, U.S. Richard M. Linnehan, U.S. Takao Doi, Japan (JAXA) Garrett E. Reisman, U.S.</p>	<p>Launched March 11, 2008 Returned March 27, 2008</p>
<p>STS 124 Space Shuttle <i>Endeavour</i> ISS flight 1J</p>				<p>Mark E. Kelly, U.S. Kenneth T. Ham, U.S. Karen L. Nyberg, U.S. Ronald J. Garan, U.S. Michael E. Fossum, U.S. Akihiko Hoshide, Japan (JAXA) Gregory E. Chamitoff, U.S.</p>	<p>Launched May 31, 2008 Returned June 14, 2008 14 days</p>
<p>STS 126 Space Shuttle <i>Atlantis</i> ISS flight ULF2</p>				<p>Christopher J. Ferguson, U.S. Eric A. Boe, U.S. Donald R. Pettit, U.S. Stephen G. Bowen, U.S. Heidemarie M. Stefanyshyn-Piper, U.S. Robert S. Kimbrough, U.S. Sandra H. Magnus, U.S.</p>	<p>Launched November 15, 2008 Returned November 30, 2008 16 days</p>
<p>STS 119 Space Shuttle <i>Endeavour</i> ISS flight 15A</p>				<p>Lee J. Archambault, U.S. Dominic A. Antonelli, U.S. Joseph M. Acaba, U.S. Steven R. Swanson, U.S. Richard R. Arnold, U.S. John L. Phillips, U.S. Koichi Wakata, Japan (JAXA)</p>	<p>Launched March 15, 2009 Returned March 28, 2009 13 days</p>
<p>STS 127 Space Shuttle <i>Discovery</i> ISS flight 2J/A</p>				<p>Mark L. Polansky, U.S. Douglas G. Hurley, U.S. Christopher J. Cassidy, U.S. Thomas H. Marshburn, U.S. David A. Wolf, U.S. Julie Payette, Canada (CSA) Timothy L. Kopra, U.S.</p>	<p>Launched July 15, 2009 Returned July 31, 2009</p>
<p>STS 128 Space Shuttle <i>Discovery</i> ISS flight 17A</p>				<p>Frederick W. Sturckow, U.S. Kevin A. Ford, U.S. Patrick G. Forrester, U.S. Jose M. Hernández, U.S. Christer Fuglesang, Sweden (ESA) John D. Olivas, U.S. Nicole P. Stott, U.S.</p>	<p>Launched August 29, 2009 Returned September 12, 2009</p>







Flight Numbers	Mission Patch	Crew Photo	Launch Package Patch	Crew	Launch, Return, Duration
<p>STS 129 Space Shuttle <i>Discovery</i> ISS flight ULF3</p>				<p>Charles O. Hobaugh, U.S. Barry E. Wilmore, U.S. Michael J. Foreman, U.S. Randolph J. Bresnik, U.S. Leland D. Melvin, U.S. Robert L. Satcher, U.S.</p>	<p>Launched November 16, 2009 Returned November 27, 2009 16 days</p>
<p>STS 130 Space Shuttle <i>Discovery</i> ISS flight 20A</p>				<p>George D. Zamka, U.S. Terry W. Virts, U.S. Kathryn P. Hire, U.S. Stephen K. Robinson, U.S. Nicholas J. Patrick, U.S. Robert L. Behnken, U.S.</p>	<p>Launched February 8, 2010 Returned February 21, 2010 13 days</p>
<p>STS 131 Space Shuttle <i>Atlantis</i> ISS flight 19A</p>				<p>Alan G. Poindexter, U.S. James P. Dutton, U.S. Richard A. Mastracchio, U.S. Clayton C. Anderson, U.S. Dorothy M. Metcalf-Lindenburger, U.S. Stephanie D. Wilson, U.S. Naoko Yamazaki, Japan (JAXA)</p>	<p>Launched April 5, 2010 Returned April 20, 2010 15 days</p>
<p>STS 132 Space Shuttle <i>Atlantis</i> ISS flight ULF4</p>				<p>Kenneth T. Ham, U.S. Dominic A. Antonelli, U.S. Stephen G. Bowen, U.S. Michael T. Good, U.S. Piers J. Sellers, U.S. Garrett E. Reisman, U.S.</p>	<p>Launched May 14, 2010 Returned May 26, 2010 11 days</p>
<p>STS 133 Space Shuttle <i>Discovery</i> ISS flight ULF5</p>				<p>Steven W. Lindsey, U.S. Eric A. Boe, U.S. Benjamin A. Drew, U.S. Michael R. Barratt, U.S. Timothy L. Kopra, U.S. Nicole P. Stott, U.S.</p>	<p>Launched May 14, 2010 Returned May 26, 2010 11 days</p>
<p>STS 134 Space Shuttle <i>Endeavour</i> ISS flight ULF6</p>				<p>Mark E. Kelly, U.S. Gregory H. Johnson, U.S. Michael Fincke, U.S. Gregory E. Chamitoff, U.S. Andrew J. Feustel, U.S. Roberto Vittori, Italy (ESA)</p>	<p>Launched May 31, 2010 Returned June 15, 2010 15 days</p>

Soyuz ISS Missions

Flight Numbers	Mission patch	Crew photo	Crew	Launch, Return, Duration
<p>TM 31 ISS flight 2R</p>			<p>Yuri Gidzenko, Russia (Roscosmos), up Sergei Krikalev, U.S., up William M. Shepherd, U.S., up Talgat Musabayev, Russia (Roscosmos), down Yuri Baturin, Russia (Roscosmos), down Dennis Tito, U.S. (SFP), down</p>	<p>Launched October 31, 2000 Returned May 6, 2001 186 days</p>
<p>TM 32 ISS flight 2S</p>			<p>Talgat Musabayev, Russia (Roscosmos), up Yuri Baturin, Russia (Roscosmos), up Dennis Tito, U.S. (SFP), up Viktor Afansayev, Russia (Roscosmos), down Claudie Hagniere, France (ESA), down Konstantin Kozayev, Russia (Roscosmos), down</p>	<p>Launched April 28, 2001 Returned October 31, 2001 186 days</p>
<p>TM 33 ISS flight 3S</p>			<p>Viktor Afansayev, Russia (Roscosmos), up Claudie Hagniere, France (ESA), up Konstantin Kozayev, Russia (Roscosmos), up Yuri Gidzenko, Russia (Roscosmos), down Roberto Vittori, Italy (ESA), down Konstantin Kozayev, Russia (Roscosmos), down</p>	<p>Launched October 21, 2001 Returned April 5, 2002 196 days</p>
<p>TM 34 ISS flight 4S</p>			<p>Yuri Gidzenko, Russia (Roscosmos), up Roberto Vittori, Italy (ESA), up Mark Shuttleworth, South Africa (SFP), up Sergei Zalyotin, Russia (Roscosmos), down Frank De Winne, Belgium (ESA), down Yuri Lonchakov, Russia (Roscosmos), down</p>	<p>Launched April 25, 2002 Returned November 10, 2002 198 days</p>
<p>TMA 1 ISS flight 5S</p>			<p>Sergei Zalyotin, Russia (Roscosmos), up Frank De Winne, Belgium (ESA), up Yuri Lonchakov, Russia (Roscosmos), up Nikolai Budarin, Russia (Roscosmos), down Kenneth Bowersox, U.S., down Donald Pettit, U.S., down</p>	<p>Launched October 30, 2002 Returned April 4, 2003 186 days</p>
<p>TMA 2 ISS flight 6S</p>			<p>Yuri Malenchenko, Russia (Roscosmos) Edward Lu, U.S. Pedro Duque, Spain (ESA), down</p>	<p>Launched April 26, 2003 Returned October 28, 2003 185 days</p>

Flight Numbers	Mission patch	Crew photo	Crew	Launch, Return, Duration
<p>TMA 3 ISS flight 7S</p>			<p>Alexander Kaleri, Russia (Roscosmos) Michael Foale, U.S. Pedro Duque, Spain (ESA), up André Kuipers, Netherlands (ESA), down</p>	<p>Launched October 18, 2003 Returned April 30, 2004 192 days</p>
<p>TMA 4 ISS flight 8S</p>			<p>Gennady Padalka, Russia (Roscosmos) E. Michael Fincke, U.S., up André Kuipers, Netherlands (ESA), up Yuri Shargin, Russia (Roscosmos), down</p>	<p>Launched April 19, 2004 Returned October 24, 2004 187 days</p>
<p>TMA 5 ISS flight 9S</p>			<p>Salizhan Sharipov, Russia (Roscosmos) Leroy Chiao, U.S. Yuri Shargin, Russia (Roscosmos), up Roberto Vittori, Italy (ESA), down</p>	<p>Launched October 14, 2004 Returned April 24, 2005 193 days</p>
<p>TMA 6 ISS flight 10S</p>			<p>Sergei Krikalev, Russia (Roscosmos) John Phillips, U.S. Roberto Vittori, Italy (ESA), up Gregory Olsen, U.S. (SFP), down</p>	<p>Launched April 15, 2005 Returned October 11, 2005 180 days</p>
<p>TMA 7 ISS flight 11S</p>			<p>Valery Tokarev, Russia (Roscosmos) William McArthur, U.S. Gregory Olsen, U.S. (SFP), up Marcos Pontes, Brazil (SFP), down</p>	<p>Launched October 1, 2005 Returned April 8, 2006 190 days</p>
<p>TMA 8 ISS flight 12S</p>			<p>Pavel Vinogradov, Russia (Roscosmos) Jeffrey Williams, U.S. Marcos Pontes, Brazil (SFP), up Anousheh Ansari, U.S. (SFP), down</p>	<p>Launched March 30, 2006 Returned September 29, 2006 182 days</p>
<p>TMA 9 ISS flight 13S</p>			<p>Mikhail Tyurin, Russia (Roscosmos) Michael Lopez-Alegria, Spain/U.S. Anousheh Ansari, U.S. (SFP), up Charles Simonyi, Hungary/U.S. (SFP), down</p>	<p>Launched September 18, 2006 Returned April 21, 2007 215 days</p>

Flight Numbers	Mission patch	Crew photo	Crew	Launch, Return, Duration
TMA 10 ISS flight 14S			Oleg Kotov, Russia (Roscosmos) Fyodor Yurchikhin, Russia (Roscosmos) Charles Simonyi, Hungary/U.S. (SFP), up Sheikh Muszaphar Shukor, Malaysia (SFP), down	Launched April 7, 2007 Returned October 21, 2007 196 days
TMA 11 ISS flight 15S			Yuri Malenchenko, Russia (Roscosmos) Peggy Whitson, U.S. Sheikh Muszaphar Shukor, Malaysia (SFP), up Yi So-Yeon, South Korea (SFP), down	Launched October 10, 2007 Returned April 19, 2008 191 days
TMA 12 ISS flight 16S			Sergei Volkov, Russia (Roscosmos) Oleg Kononenko, Russia (Roscosmos) Yi So-Yeon, South Korea (SFP), up Richard Garriott, U.S. (SFP), down	Launched April 8, 2008 Returned October 24, 2008 199 days
TMA 13 ISS flight 17S			Yuri Lonchakov, Russia (Roscosmos) Michael Fincke, U.S. Richard Garriott, U.S. (SFP), up Charles Simonyi, Hungary/U.S. (SFP), down	Launched October 12, 2008 Returned April 8, 2009 178 days
TMA 14 ISS flight 18S			Gennady Padalka, Russia (Roscosmos) Michael Barratt, U.S. Charles Simonyi, Hungary/U.S. (SFP), up Guy Laliberté, Canada (SFP), down	Launched March 26, 2009 Returned October 11, 2009 199 days
TMA 15 ISS flight 19S			Roman Romanenko, Russia (Roscosmos) Frank De Winne, Belgium (ESA) Robert Thirsk, Canada (CSA)	Launched May 27, 2009 Returned December 1, 2009 188 days
TMA 16 ISS flight 20S			Maksim Surayev, Russia (Roscosmos) Jeffrey Williams, U.S. Guy Laliberté, Canada (SFP), up	Launched September 30, 2009 Returned March 18, 2010 169 days

Flight Numbers	Mission patch	Crew photo	Crew	Launch, Return, Duration
TMA 17 ISS flight 7S			Oleg Kotov, Russia (Roscosmos) Timothy Creamer, U.S. Soichi Noguchi, Japan (JAXA)	Launched December 20, 2009 Returned June 2, 2010 164 days
TMA 18 ISS flight 22S			Aleksandr Skvortsov, Russia (Roscosmos) Mikhail Korniyenko, Russia (Roscosmos) Tracy Caldwell Dyson, U.S.	Launched April 2, 2010
TMA 19 ISS flight 23S			Fyodor Yurchikhin, Russia (Roscosmos) Shannon Walker, U.S. Douglas H. Wheelock, U.S.	Launched June 15, 2010



Unmanned ISS Missions

Flight Number	ISS Flight Number	Launch Date	Deorbit	Type
Progress M1-3	ISS 1P	August 6, 2000	November 1, 2000	Supplies
Progress M1-4	ISS 2P	November 18, 2000	December 1, 2000	Supplies
Progress M1-5	ISS 3P	February 26, 2001	April 16, 2001	Supplies
Progress M1-6	ISS 4P	May 21, 2001	August 22, 2001	Supplies
Progress M-45	ISS 5P	August 21, 2001	November 22, 2001	Supplies
Progress M1-7	ISS 6P	November 26, 2001	March 19, 2002	Supplies
Progress M1-8	ISS 7P	March 21, 2002	June 25, 2002	Supplies
Progress M-46	ISS 8P	June 26, 2002	September 24, 2002	Supplies
Progress M1-9	ISS 9P	September 25, 2002	February 1, 2003	Supplies
Progress M-47	ISS 10P	February 2, 2003	August 27, 2003	Supplies
Progress M1-10	ISS 11P	June 8, 2003	September 4, 2003	Supplies
Progress M-48	ISS 12P	August 29, 2003	January 28, 2004	Supplies
Progress M1-11	ISS 13P	January 29, 2004	May 24, 2004	Supplies
Progress M-49	ISS 14P	May 25, 2004	July 30, 2004	Supplies
Progress M-50	ISS 15P	August 11, 2004	December 22, 2004	Supplies
Progress M-51	ISS 16P	December 23, 2004	February 27, 2005	Supplies
Progress M-52	ISS 17P	February 28, 2005	June 15, 2005	Supplies
Progress M-53	ISS 18P	June 16, 2005	September 7, 2005	Supplies
Progress M-54	ISS 19P	September 8, 2005	March 3, 2006	Supplies
Progress M-55	ISS 20P	December 21, 2005	June 19, 2006	Supplies
Progress M-56	ISS 21P	April 24, 2006	September 19, 2006	Supplies
Progress M-57	ISS 22P	June 24, 2006	January 16, 2006	Supplies
Progress M-58	ISS 23P	October 23, 2006	March 27, 2007	Supplies
Progress M-59	ISS 24P	January 18, 2007	August 1, 2007	Supplies
Progress M-60	ISS 25P	May 12, 2007	September 19, 2007	Supplies
Progress M-61	ISS 26P	August 2, 2007	December 22, 2007	Supplies
Progress M-62	ISS 27P	December 23, 2007	February 4, 2008	Supplies
Progress M-63	ISS 28P	February 5, 2008	April 7, 2008	Supplies




Flight Number	ISS Flight Number	Launch Date	Deorbit	Type
ATV Jules Verne	ISS-ATV1	March 9, 2008	September 29, 2008	Demonstration of European Automated Transfer Vehicle Jules Verne (ATV), Supplies
Progress M-64	ISS 29P	May 14, 2008	September 1, 2008	Supplies
Progress M-65	ISS 30P	September 10, 2008	November 14, 2008	Supplies
Progress M-01M	ISS 31P	November 26, 2008	February 6, 2009	Supplies
Progress M-66	ISS 32P	February 10, 2009	May 6, 2009	Supplies
Progress M-02M	ISS 33P	May 7, 2009	July 13, 2009	Supplies
Progress M-67	ISS 34P	July 24, 2009	September 27, 2009	Supplies
HTV-1	ISS-HTV1	September 10, 2009	November 1, 2009	Demonstration of Japanese H-II Transfer Vehicle (HTV), Supplies
Progress M-03M	ISS 35P	October 15, 2009	April 27, 2010	Supplies
Progress M-04M	ISS 36P	February 3, 2010	July 1, 2010	Supplies
Progress M-05M	ISS 37P	April 28, 2010		Supplies
Progress M-06M	ISS 38P	June 30, 2010		Supplies





appendix



NASA wishes to acknowledge the use of images provided by these organizations:

Canadian Space Agency

European Space Agency

Japan Aerospace Exploration Agency

Roscosmos, the Russian Federal Space Agency

Orbital Sciences Corporation

SpaceX Exploration Technologies Corporation

Thales Alenia Space

S.P. Korolev Rocket and Space Corporation Energia

To Learn More

Space Station Science

http://www.nasa.gov/mission_pages/station/science/

Facilities

http://www.nasa.gov/mission_pages/station/science/experiments/Discipline.html

ISS Interactive Reference Guide

<http://www.nasa.gov/externalflash/ISSRG>

Canadian Space Agency (CSA)

<http://www.asc-csa.gc.ca/eng/iss/>

European Space Agency (ESA)

<http://www.esa.int/esaHS/iss.html>

Japan Aerospace Exploration Agency (JAXA)

<http://iss.jaxa.jp/en/>

Russian Federal Space Agency (Roscosmos)

<http://knts.rsa.ru/>

<http://www.energia.ru/english/index.html>

Acronym List

A

ABRS	Advanced Biological Research System
ACES	Atomic Clock Ensemble in Space
ACU	Arm Control Unit
ADUM	Advanced Diagnostic Ultrasound in Microgravity
ALTEA	Anomalous Long Term Effects in Astronauts' Central Nervous System
AMS	Alpha Magnetic Spectrometer
APFR	Articulating Portable Foot Restraint
AQH	Aquatic Habitat
ARC	Ames Research Center
ARED	Advanced Resistive Exercise Device
ARIS	Active Rack Isolation System
ASI	Italian Space Agency
ASIM	Atmosphere Space Interaction Monitor
ATCS	Active Thermal Control System
ATF	Astronaut Training Facility
ATV	Automated Transfer Vehicle
ATV-CC	ATV Control Center

B

BCA	Battery Charging Assembly
BCDU	Battery Charge Discharge Unit
BIOLAB	Biological Laboratory
BISE	Bodies In the Space Environment
BSA	Battery Stowage Assembly
BSTC	Biotechnology Specimen Temperature Controller

C

C	Celsius
CADMOS	Centre d'Aide au Développement des activités en Micropesanteur et des Opérations Spatiales
CB	Clean Bench
CBEF	Cell Biology Experiment Facility
CBM	Common Berthing Mechanism

CCAA	Common Cabin Air Assembly
CCD	Charge-Coupled Device
CDRA	Carbon Dioxide Removal Assembly
CEO-IPY	Crew Earth Observations-International Polar Year
CEPF	Columbus External Payload Facility
CEVIS	Cycle Ergometer with Vibration Isolation System
CGBA	Commercial Generic Bioprocessing Apparatus
CHECS	Crew Health Care System
CIR	Combustion Integrated Rack
CKK	Replaceable Cassette-Container
CM	centimeter
CMG	Control Moment Gyroscope
CMRS	Crew Medical Restraint System
CMS	Countermeasures System
CNES	Centre National d'Études Spatiales (French Space Agency)
CO ₂	carbon dioxide
COLBERT	Combined Operational Load Bearing External Resistive Exercise Treadmill
COL-CC	Columbus Control Center
CRPCM	Canadian Remote Power Controller Module
CRS	Commercial Resupply System
CSA	Canadian Space Agency
CWC	Contingency Water Container
D	
DC	Docking Compartment
DC	Direct Current
DCSU	Direct Current Switching Unit
DDCU	DC-to-DC Converter Unit
DECLIC	Device for the study of Critical Liquids and Crystallization
DLR	Deutsches Zentrum für Luft- und Raumfahrt e.V. (German Aerospace Center)
DLS	Dynamic Light Scattering
DOE	Department of Energy
DRTS	Data Relay Test Satellite

E

EAC	European Astronaut Centre
EADS	European Aeronautic Defence and Space Company
ECG	electrocardiogram
ECLSS	Environmental Control and Life Support System
ECU	Electronics Control Unit
EDR	European Drawer Rack
EF	Exposed Facility
EHS	Environmental Health System
ELC	EXPRESS Logistics Carriers
ELITE-S2	ELaboratore Immagini Televisive-Space 2
ELM-PS	Experiment Logistics Module-Pressurized Section
EMCS	European Modular Cultivation System
EMU	Extravehicular Mobility Unit
EPM	European Physiology Module
EPS	Electrical Power System
ERA	European Robotic Arm
ESA	European Space Agency
ESTEC	European Space Research and Technology Centre
EUTEF	European Technology Exposure Facility
EVA	extravehicular activity
EVARM	EVA Radiation Monitor
EXPCA	EXPRESS Carrier Avionics
EXPOSE	Exposure Experiment
EXPRESS	Expedite the Processing of Experiments to the Space Station

F

F	Fahrenheit
FDA	Food and Drug Administration
FGB	Functional Cargo Block
FIR	Fluids Integrated Rack
FOOT	Foot Reaction Forces During Spaceflight
PFEF	Fluid Physics Experiment Facility
FRAM	Flight Releasable Attachment Mechanism
FRGF	Flight Releasable Grapple Fixture
FSA	Farm Service Agency
FSA	Russian Federal Space Agency
FSL	Fluid Science Laboratory
FT	foot

G

GASMAP	Gas Analyzer System for Metabolic Analysis Physiology
GCM	Gas Calibration Module
GCTC	Gagarin Cosmonaut Training Center
GHF	Gradient Heating Furnace
GLACIER	General Laboratory Active Cryogenic ISS Equipment Refrigerator
GLONASS	Global Navigation Satellite System
GN&C	Guidance, Navigation, and Control
GPS	Global Positioning System
GRC	Glenn Research Center
GSC	Guiana Space Centre
GTS	Global Transmission Services

H

H ₂	hydrogen
H ₂ O	water
HEPA	High Efficiency Particulate Air
HMS	Health Maintenance System
HPA	Hand Posture Analyzer
HQ	Headquarters
HQL-79	human hematopoietic prostaglandin D2 synthase inhibitor
HR	hour
H-REFLEX	Hoffman Reflex
HRF	Human Research Facility
HTV	H-II Transfer Vehicle
HTVCC	HTV Control Center

I

ICS	Interorbit Communications System
IEA	Integrated Equipment Assembly
IFU	In-Flight Refill Unit
IMBP RAS	Institute for Medical and Biological Problems of Russian Academy of Sciences
IN	inch
IND	Investigational New Drug
IPU	Image Processing Unit
ISIS	International Subrack Interface Standard
ISPR	International Standard Payload Rack

ITS	Inertial Tracking System
ITS	Integrated Truss Structure
IV-CPDS	Intravehicular Charged Particle Directional Spectrometer

J

JAXA	Japan Aerospace Exploration Agency
JEM	Japanese Experiment Module
JEMMC	JEM Mission Control
JPM	Japanese Pressurized Module
JSC	Johnson Space Center

K

K	Kelvin
KG	kilogram
KM	kilometer
KPA	kilopascals
KSC	Kennedy Space Center
KW	kilowatt

L

L	liters
LB	pound
LBF	pound-force
LED	Light Emitting Diode
LIOH	Lithium Hydroxide
LMM	Light Microscopy Module
LOCAD-PTS	Lab-on-a-Chip Application Development-Portable Test System

M

M	meter
M ³	cubic meter
MARES	Muscle Atrophy Research Exercise System
MATRYOSHKHA	Measuring Radiation Hazards in Space
MAXI	Monitor of All-sky X-ray Image
MBPS	Megabits Per Second
MBSU	Main Bus Switching Unit
MCC	Mission Control Center
MDS	Mice Drawer System
MELFI	Minus Eighty-Degree Laboratory Freezer for ISS
MEPS	Microencapsulation Electrostatic Processing System
MERLIN	Microgravity Experiment Research Locker/Incubator

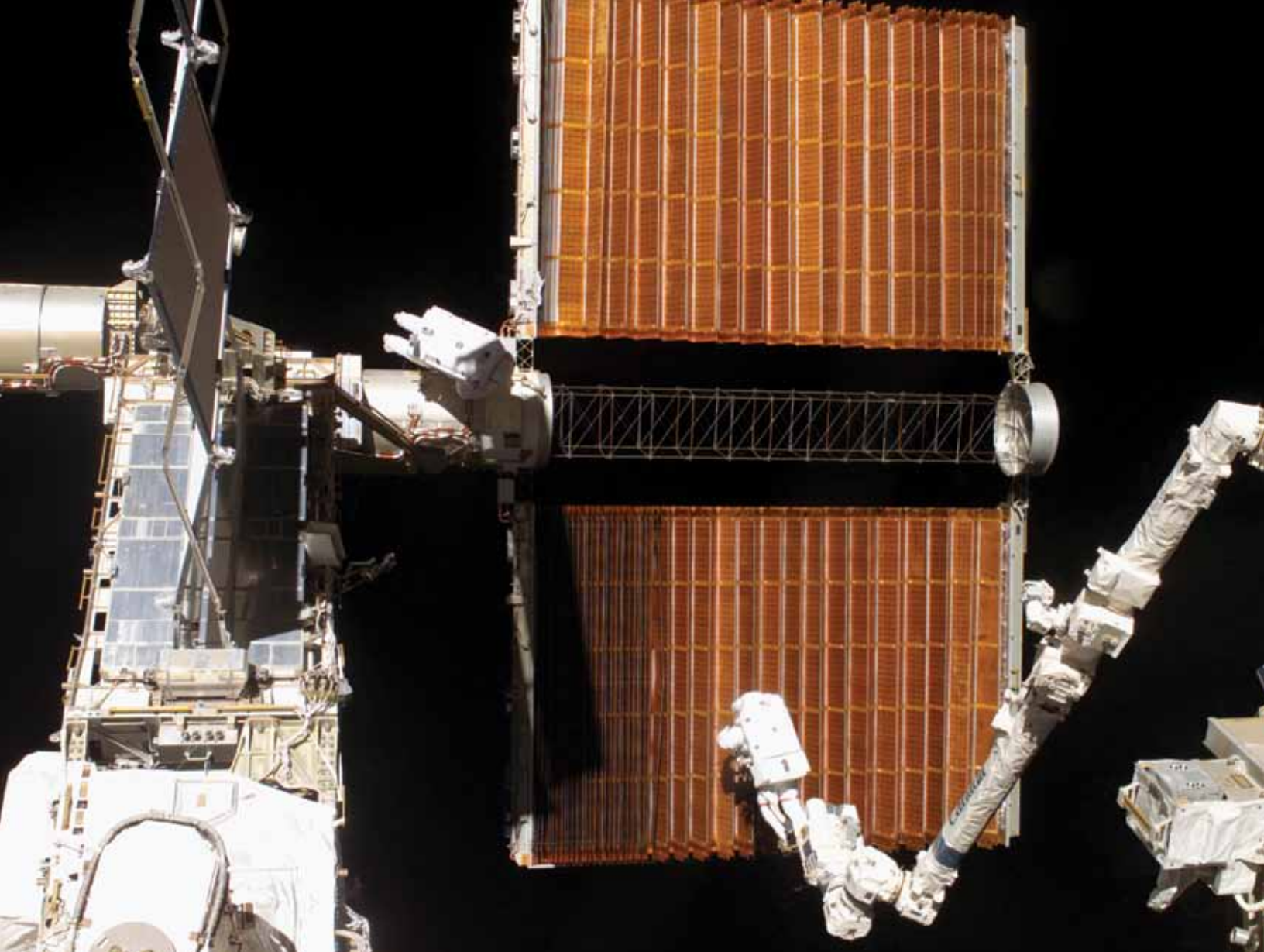
MICAST	Microstructure Formation in Casting of Technical Alloys under Diffusive and Magnetically Controlled Convective Conditions	P		SEDA-AP	Space Environment Data Acquisition equipment-Attached Payload
MIL-STD	Military Standard	PBG	Portable Glove Box	SFOG	Solid Fuel Oxygen Generator
MISSE	Materials International Space Station Experiment	PCAS	Passive Common Attach System	SGANT	Space to Ground Antenna
MLM	Multi-Purpose Laboratory Module	PCDF	Protein Crystallization Diagnostics Facility	SHS	Super-High temperature Synthesis
MMOD	Micrometeoroid and Orbital Debris	PCRF	Protein Crystallization Research Facility	SLAMMD	Space Linear Acceleration Mass Measurement Device
MMU	Multiplexer/Demultiplexer Mass Memory Unit	PDGF	Power Data Grapple Fixture	SM	Service Module
MOC	MSS Operations Complex	PEMS	Percutaneous Electrical Muscle Stimulator	SMILES	Superconducting Submillimeter-wave Limb-emission Sounder
MPLM	Multi-Purpose Logistics Module	PFS	Pulmonary Function System	SPDM	Special Purpose Dexterous Manipulator
MRM	Mini-Research Module	PLANTS-2	BIO-5 Rasteniya-2	SPP	Science Power Platform
MRSA	methicillin-resistant <i>Staphylococcus aureus</i>	PLSS	Primary Life Support Subsystem	SRV-K	Russian Condensate Water Processor
MSFC	Marshall Space Flight Center	PMA	Pressurized Mating Adaptor	SSA	Space Suit Assembly
MSG	Microgravity Sciences Glovebox	PMDIS	Perceptual Motor Deficits in Space	SSC	Space Station Computer
MSL	Materials Science Laboratory	PMM	Permanent Multipurpose Module	SSRMS	Space Station Remote Manipulator System
MSL-CETSOL	Materials Science Laboratory—Columnar-to-Equiaxed Transition in Solidification	POIC	Payload Operations and Integration Center	SSU	Sequential Shunt Unit
MSPR	Multipurpose Small Payload Rack	PSA	Power Supply Assembly	T	
MSRR	Materials Science Research Rack	PTCS	Passive Thermal Control System	TAS-I	Thales Alenia Space Italy
MSS	Mobile Servicing System	PTOC	Payload Telescience Science Operations Center	TCS	Thermal Control System
MT	Mobile Transporter	PVGf	Power Video Grapple Fixture	TDRS	Tracking and Data Relay Satellites
MUSC	Microgravity User Support Centre	PWP	Portable Work Post	TEPC	Tissue Equivalent Proportional Counter
MZI	Mach-Zehnder Interferometry	R		TMA	Transportation Modified Anthropometric
N		ROEU-PDA	Remotely Operated Electrical Umbilical-Power Distribution Assembly	TMG	Thermal Micrometeoroid Garment
N ₂	nitrogen	RPC	Remote Power Controller	TNSC	Tanegashima Space Center
N ₂ O ₄	nitrogen tetroxide	RPCM	Remote Power Controller Module	TORU	American Usage of Russian Term (TOPY)
NASA	National Aeronautics and Space Administration	RPM	revolutions per minute	TSC	Telescience Support Centers
NAVSTAR	Navigation Signal Timing and Ranging	RSC ENERGIA	S.P. Korolev Rocket and Space Corporation Energia	TSKC	Tsukuba Space Center
NORS	Nitrogen/Oxygen Resupply System	S		TSNIIMASH	Central Scientific Research Institute for Machine Building
NTSC	National Television Standards Committee	SAFER	Simplified Aid For EVA Rescue	TSUP	Moscow Mission Control Center
O		SARJ	Solar (Array) Alpha Rotation Joint	TVIS	Treadmill Vibration Isolation System
O ₂	oxygen	SASA	S-Band Antenna Structural Assembly	U	
OBSS	Orbiter Boom Sensor System	SAW	Solar Array Wing	U.S.	United States
OGS	Oxygen Generation System	SCOF	Solution Crystallization Observation Facility	UDMH	unsymmetrical dimethyl hydrazine
ORU	Orbital Replacement Unit				

UHF	Ultra High Frequency
UMA	Umbilical Mating Assembly
USOC	User Support and Operation Centers
USOS	U.S. On-orbit Segment
V	
VDC	voltage, direct current
VDU	Video Distribution Unit
VHF	very high frequency
VOA	Volatile Organics Analyzer
W	
WAICO	Waving and Coiling of Arabidopsis Roots at Different g-levels
WHC	Waste Hygiene Compartment
WORF	Window Observational Research Facility
WPA	Water Processing Assembly
WRS	Water Recovery System

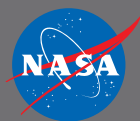
Definitions

ASSEMBLY COMPLETE	Final integrated arrangement of the International Space Station elements
ASSEMBLY STAGE	Integrated arrangement of International Space Station elements
BERTHING	Mating or linking operations of two spacecraft, modules, or elements where an inactive module/vehicle is placed into the mating interface using a Remote Manipulator System
DOCKING	Mating or linking operations of two spacecraft, modules, or elements where an active vehicle flies into the mating interface under its own power
ELEMENT	A structural component such as a module or truss segment
EXPEDITION	A long-duration crew during a stay on the space station
INCREMENT	Period of time from launch of a vehicle rotating International Space Station crewmembers to the undocking of the return vehicle for that crew
MISSION	Flight of a “visiting” Space Shuttle, Soyuz, or other vehicle not permanently attached to the International Space Station
MODULE	An internally pressurized element intended for habitation
MULTIPLEXER	A computer that interleaves multiple data management functions
NADIR	Direction directly below (opposite zenith)
PORT	Direction to the left side (opposite starboard)
RENDEZVOUS	Movement of two spacecraft toward one another
SPACE FLIGHT PARTICIPANT	Nonprofessional astronaut
STARBOARD	Direction to the right side (opposite port)
ZENITH	Directly above, opposite nadir





ISS Partners:



United States of America
www.nasa.gov



Canada
www.space.gc.ca/asc/eng/default.asp



Japan
www.jaxa.jp/index_e.html



Russian Federation
www.roscosmos.ru



European Space Agency
www.esa.int



ISBN 978-0-16-086517-6



9 780160 865176